



Air Check ✓

O₂ Deficiency Monitor 0-95%

Instruction Manual

For model DRA **Part number 99048**



PureAire Monitoring Systems, Inc.

1140 Ensell Road
Lake Zurich, Illinois 60047
Phone: 847-726-6000
Fax: 847-726-6051
Toll-Free: 888-788-8050
pureairemonitoring.com
Rev 4.14 May, 2024

Welcome to PureAire Monitoring Systems

I would like to thank you for investing in our continuous life safety and process control toxic gas monitoring systems.

PureAire offers an unbeatable combination of experience and innovation in solving the safety and environmental needs of our customers. We can provide small systems of a few points to a total multi-point turnkey computerized package.

PureAire's proprietary sensor cell technology and state-of-the-art electronics are designed to interface with the latest distributive or PLC based control systems. We believe that our experience, innovative products, and commitment to service will satisfy your specific monitoring needs now and in the future.

Our growth is a result of our total commitment to supporting our customers. We are available 24 hours a day, 7 days a week to help you when you need us. Our 24 hour Emergency phone number is 1-224-443-5445. We can provide field service, preventative maintenance programs and training to your technicians in the operation of our equipment. Our goal is to provide the best after sale service and support in the industry. That is just one way PureAire takes that extra step to ensure your complete satisfaction.

Thank you again for investing in PureAire Monitoring Systems for your monitoring needs and I am proud to welcome you to our family of valued and satisfied customers.

Sincerely,



**Albert A. Carrino
President**

Please Read Before Installation

The following will damage the Air Check Oxygen monitor.

1. The Air Check O₂ monitor requires **24 VDC regulated power**. **Please Do Not connect** the monitor to any voltage that exceeds 24 Volts DC, or **ANY AC Voltage**.
2. Do not power the Air Check Oxygen monitor with the oxygen sensor unplugged from the main PC board. **Do Not Connect** the O₂ sensor to the PC board while the monitor is powered. This Will Damage the O₂ sensor.
3. The oxygen sensor cell is matched to the electronics. **Never exchange** the electronics with an oxygen sensor from a different monitor.
4. When calibrating or challenging the Air check O₂ Ex monitors,
 - a. Do not expose the monitor to flow rates that exceed ½ liter per minute, (500 cc per minute) flow.
 - b. Expose the monitor to span gas blends that consist of Oxygen and Nitrogen only. **Do Not expose the monitor to any combustible gas**, i.e., Methane, Hydrogen, etc. Exposure to combustible span gases can damage the oxygen zirconium sensor cell.
5. Do not expose the Oxygen monitor to silicone, Freon, or corrosive compounds. They can cause a loss of sensitivity and damage the sensor.
6. Do not expose the monitor to high flow air or install it directly in front of fans. The high air flow can cool the oxygen sensor and cause an inaccurate reading.
7. When using the Air Check O₂ monitor, Do not expose the oxygen sensor directly to a water stream. In areas requiring wash downs, cover and protect the monitor and power supply. Contact PureAire for details on a waterproof enclosure.
- 8. The Factory Password for entering the menus is 557**

Table of Contents

1: Introduction	2
1.1 Key Features	2
1.2 Component identification	3
2: Specifications.....	7
2.1 Performance Specifications	7
2.2 Gas Detection System.....	7
2.3 Signal Outputs	7
2.4 Electrical Requirements.....	7
2.5 Physical Characteristics	7
2.6 System Default Factory Settings	8
3: Installation	9
3.1 Site Requirements.....	9
3.2 Mounting.....	9
3.3 Wiring.....	10
3.4 Initial Startup	10
4: Normal Operation.....	11
4.1 Signal Outputs	11
4.2 Instrument Faults	11
4.3 Routine Maintenance Schedule	12
4.4 Loss of Power Indicator.....	12
4.5 Alarm Reset	13
5: Air Check O ₂ Monitor Programming	14
5.1 Joystick Operation	14
5.2 Program Flowchart	15
5.3 Entering the Password	18
5.4 Changing the User Password.....	19
5.5 Entering the Menus.....	22
5.5.1 Set 4-20mA Loop	22
5.5.2 Set Formats	24
5.5.3 Set Alarm Threshold Polarity	26
5.5.4 Set Latching	28
5.5.5 Resetting a Latching Alarm	31
5.5.6 Set Alarm Delay	31
5.5.7 Set Zero Suppression	32
5.5.8 Set Alarm Thresholds	32
5.5.9 Set Alarm Hysteresis	34
5.5.10 Set Sensor Adjust.....	35
5.5.11 Main Operation Mode.....	36
6: Maintenance & Cell Verification	37
6.1 Sensor Verification	37
6.2 Sensor Verification Procedure.....	38
7: Appendix	41

1: Introduction

The *Air Check* ✓O₂ Deficiency Monitor is a compact gas monitoring system that is ideal for the continuous monitoring of inert gas storage areas, confined spaces, and other locations where low oxygen levels may pose a hazard to personnel. Unlike electrochemical sensor cells the *Air Check* ✓O₂ zirconium cell provides stable oxygen readings even in areas where temperature and humidity levels are changing. The PureAire *Air Check* ✓O₂ Deficiency Monitor is suitable for either indoor or outdoor use. Factory calibrated against a NIST traceable reference standard and UL/ CUL and Ce approved.

The heart of the monitoring system is a long-lasting zirconium sensor, which responds to low oxygen conditions within seconds and provides accurate measurements over a wide temperature and humidity range. The zirconium O₂ sensor cell will operate continuously for 10 or more years and requires an absolute minimum of maintenance. There are no zero or span calibration pots to adjust and when compared to disposable type sensors, our long-life zirconium O₂ sensor can save up to hundreds of dollars in annual maintenance.

Ideal for continuously monitoring oxygen levels in confined spaces or areas where inert gases are used, the *Air Check* ✓O₂ Deficiency Monitor does not drift or lose sensitivity when the weather or temperature changes. The electronics are housed in a Nema 2 housing. *

Each system consists of a long-life zirconium oxide sensor cell and three-wire transmitter. The *Air Check* ✓O₂ monitor may be used as a stand-alone gas detector, linked to optional PureAire single and multipoint controllers, or connected to your own centralized control and surveillance system. This manual covers the installation, operation, and maintenance of the *Air Check* ✓O₂ deficiency monitor.

1.1 Key Features

The *Air Check* ✓O₂ monitor incorporates several user-friendly features designed to simplify installation, operation, and maintenance.

1.1.1 Long Life Zirconium Oxide O₂ Sensor

The system's O₂ sensor cell has a life of well over 10 years of continuous operation. Unlike concentration O₂ cells, PureAire's exclusive zirconium oxide sensor cell does not need an oxygen reference gas for proper operation. The *Air Check* ✓O₂ monitor can detect low oxygen levels in confined spaces and process tools without the need of a reference gas.

1.1.2 Smart Electronics

The *Air Check* ✓O₂ monitor incorporates a special electronic circuit that continuously monitors sensor operation. With the addition of the alarm relay option, any cell degradation or complete failure will immediately be detected. This smart circuitry alerts the user to sensor faults and other electrical problems that may interrupt surveillance through the standard mA signal output signal and through the fault relay.

* For washdown areas use p/n 99118

1.1.3 Calibration

The *Air Check* ✓O₂ monitor incorporates a stable zirconium oxide sensor that rarely requires adjustment. Changing barometric pressure changes or changes in temperature and humidity do not affect the zirconium oxide oxygen cell. The earth is a wonderful source of calibrated oxygen at 20.9%, therefore under ambient conditions, visual verification of the *Air Check* ✓O₂ monitor to 20.9% oxygen is easily performed. There are no zero or span pots to adjust. The O₂ monitor only requires periodic testing with nitrogen to verify the cells response to low oxygen levels. See Section 6.2 for the testing procedure to nitrogen.

1.2 Component Identification

1.2.1 Front View Exterior

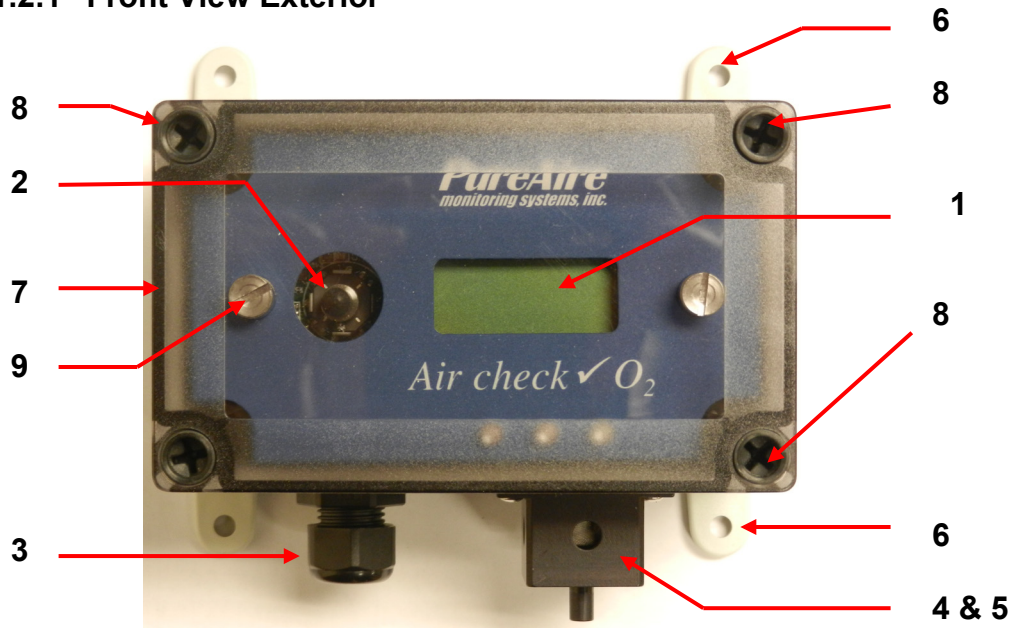

1. **Digital Display** — 3-digit backlit LCD digital display for showing the oxygen levels in percent.
2. **Joystick** — Used for selecting and adjusting the built-in menus. The *Air Check* ✓O₂ monitor is available with optional dual level user selectable relays. The joystick is also used to select alarm levels, relay settings and resetting any latching visual and audio alarms.
3. **Cable Port** — This is the opening in the transmitter housing for connecting the 4-20 mA output and 24 VDC power cable.
4. **Sensor Protector**—The O₂ sensor is heated, and the sensor protector shields the cell as well as provides airflow to the cell. It also has a ¼ “ diameter tube fitting to permit connecting a nitrogen cylinder for testing the O₂ cell response. **NOTE: The sensor protector will feel HOT to the touch. This is normal.**
5. **Oxygen Sensor** — A zirconium oxide sensor, which detects and measures the level of oxygen. When exposed to oxygen, the sensor outputs an electrical signal proportional to the actual concentration of oxygen.
6. **Mounting Feet** — There are 4 feet used to mount the oxygen monitor to a wall or other flat surface.

- 7. **Transmitter Cover** — A removable cover that protects the interior of the transmitter.
- 8. **Transmitter Cover Fasteners** — There are 4 captive screws secure the transmitter cover in place.
- 9. **Electronics Fasteners** — These captive screws secure the electronics to the enclosure

1.2.2 Front View Exterior with Relay Option

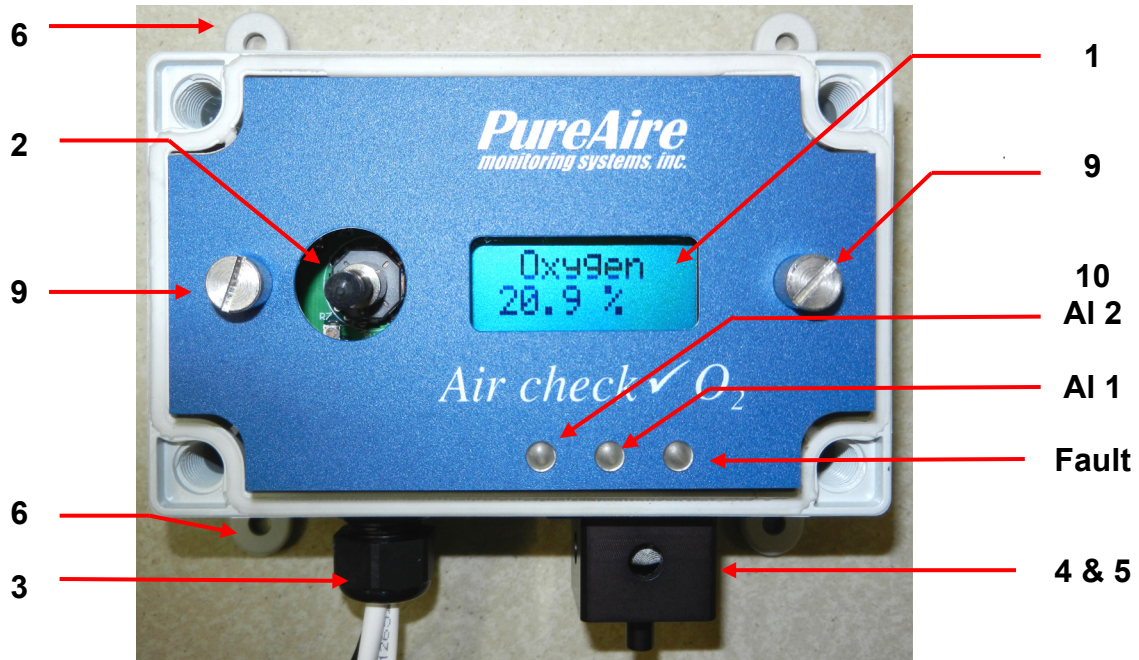

- 10. Alarm Indicators** — 3 multicolored LED indicators for showing:
- | | |
|---------------|------------|
| Alarm level 1 | Orange LED |
| Alarm level 2 | Red LED |
| Fault Alarm | Yellow LED |

1.2.3 Side View Exterior with Audio Alarm

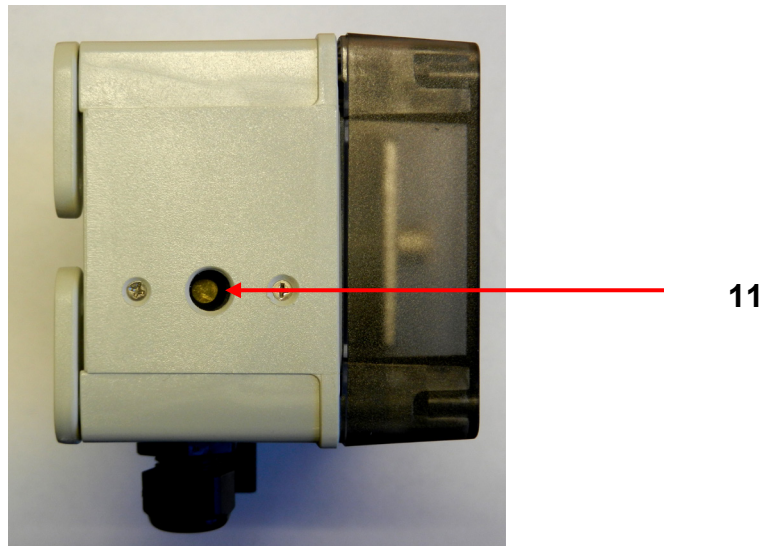

- 11. **Audio Horn** — This optional built-in horn is a 90dB high pitched audio sound that will activate when the oxygen levels go below the selected alarm thresholds. The audio alarm is non-latching and will automatically turn off when the oxygen levels go above the alarm thresholds

NOTE: The audio alarm is an immediate alarm. Oxygen levels must recover above the alarm thresholds before the horn turns off. There is no alarm delay function available.

1.2.5 Transmitter Interior

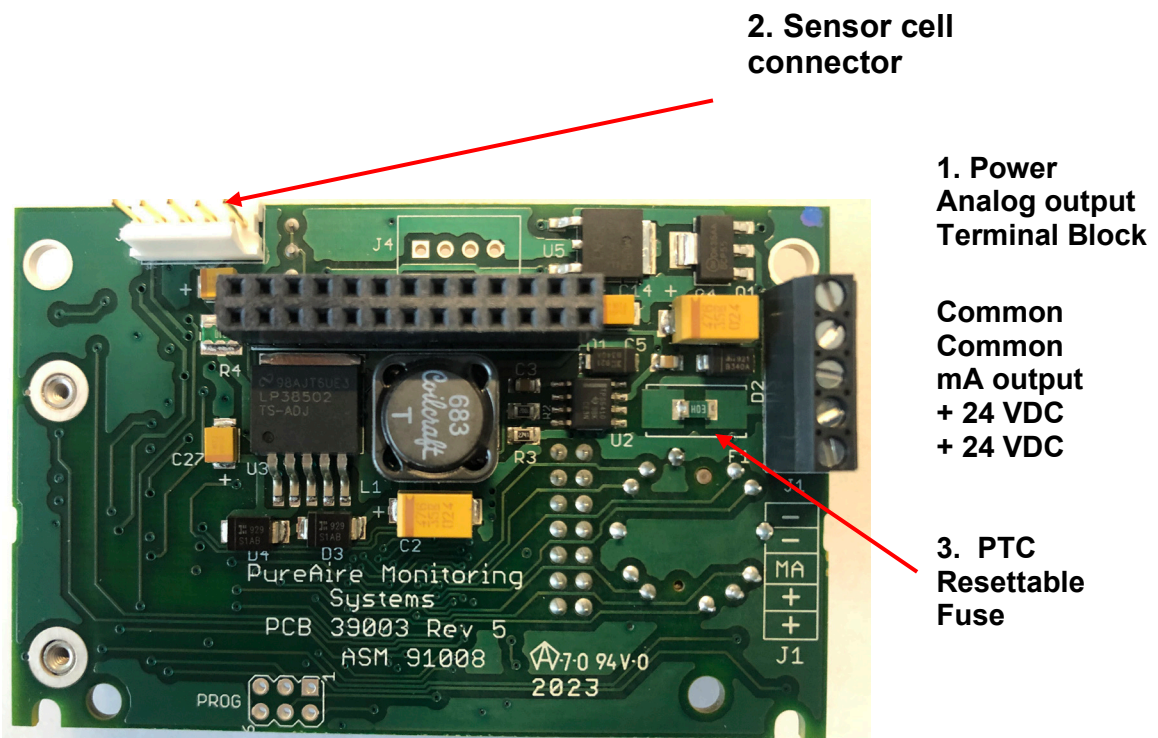

- 1. **Power Analog Terminal Block** — This terminal block is where the 24VDC power and 4-20 mA analog output connection is made.
- 2. **Sensor Cell Connector** — This connector is where the Oxygen sensor cell is connected. **NOTE: Never connect the oxygen sensor to this connector while the monitor is powered. This will damage the oxygen sensor**
- 3. **PTC Resettable Fuse** — The PCB is protected with a PTC Fuse that is resettable and Never needs to be replaced. If it trips, you will need to turn power off to the monitor. When power resumes the fuse will reset.

1.2.7 Alarm Relay Board

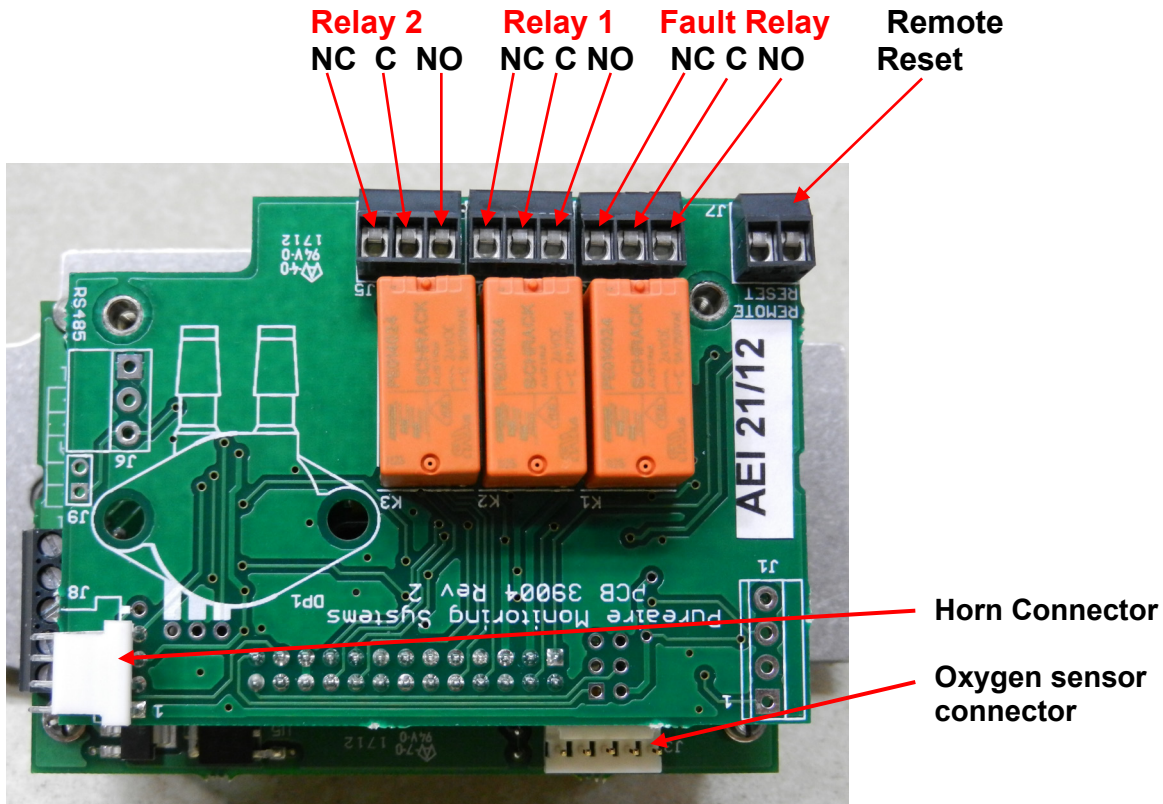

1.2.8 Enclosure Mounting Feet

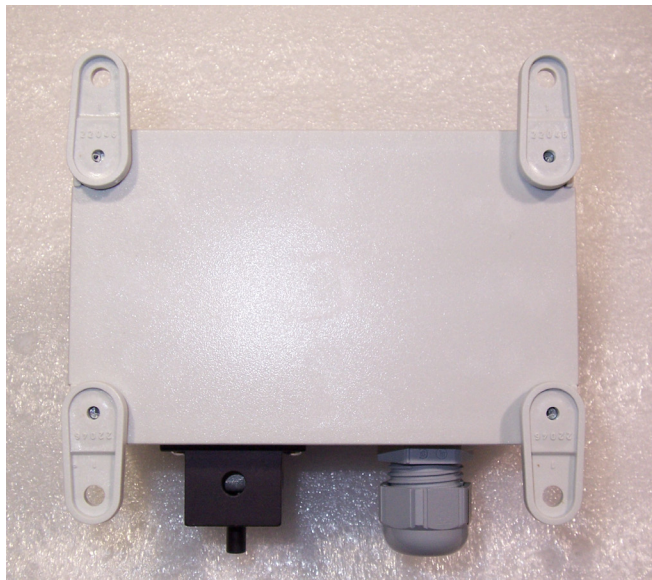

**Mounting Feet
Can be oriented
in any direction**

**Feet can also be
removed for
mounting the O₂
monitor flush
with a wall or
other surface**

2: Specifications

NOTE: For our continual product improvement, all specifications are subject to change without notice.

2.1 Performance Specifications

Sensor Type:	Long Life Zirconium Oxide Sensor Cell 0-95%
Response Time:	Within 1 second of any change in O ₂ .
Accuracy:	Delivers $\pm 0.2\%$ O ₂ accuracy ($\pm 1\%$ of full range)
Fault Indicators:	Loss of VDC power (analog signal drops to 0 mA). Sensor cell failure: Fault relay activated. (Must have Alarm relay option for cell failure to operate)
Operating Temp:	-40° to 140°F (-40° to +60°C); consult PureAire for lower or higher operating temperatures.
Humidity:	0 to 95% RH; consult PureAire for sensors which can operate in 100% condensing RH environments.
Environment:	Altitude 2000 m, PSU only UL spec. Pollution Degree 3, Intended for Indoor Use.
UL / CUL listing:	Measuring Equipment E363306
Ce	EN 61000-3-2:2006 EMC, EN 61000-3-3:2008 EMC, EN61010-1-3-2013 LVD

2.2 Gas Detection System

Type:	Long Life Zirconium Oxide Sensor Cell, Range 0-95%
Sensor Life:	8 to 10+ years under normal conditions.
Transmitter:	Microprocessor electronics with built-in 3-digit backlit LCD display Joystick operated menus

2.3 Signal Outputs

Local Display:	Digital display calibrated for Oxygen. The range is stated on the model label and can also be accessed via the joystick on the front panel. In the measurement mode pushing the joystick down will scroll the gas and range on the display. Push the joystick down again to stop the scrolling and display the gas again.
Standard	Analog Output: DC 4-20 mA Relay Output: Dual level user selectable alarm relays and one fault relay Rated, 2amps @ $\leq 24\text{VAC}$ or 24VDC

2.4 Electrical Requirements

Power:	24 VDC external power. A regulated 24VDC power supply is required.
Consumption:	Approximately 250mA

2.5 Physical Characteristics

Dimensions:	5.125 (W) x 3.15 (H) x 3.00 (D) inches; 130 x 80 x 76 mm (Max with feet)
Weight:	1.1 pounds (0.5 kg)
Enclosure Type:	General purpose, Nema 2; not intended for explosive atmospheres.

2.6 AirCheck O₂ System Default Factory settings

The *Air Check* ✓O₂ Deficiency Monitor, when supplied with the optional Relay module, is shipped with factory defaults for the alarm relay settings. The following are the factory defaults:

Menu Function	Factory Default	Menu Defined
Set 4-20mA loop	The mA output is set at the factory using a calibrated Fluke meter.	Use this function to adjust the Oxygen monitors 4mA, (Zero) and 20mA, (Span) to your PLC or distributive control system.
Set Formats LED and alarm relay State **	Alarm 1 = Normal Alarm 2 = Normal Fault = Normal	Do you want the relays to energize, (normal) or de-energize, (fail safe) when the alarm activates?
Set Alarm Threshold Polarity	Alarm 1 = Inverted Alarm 2 = Inverted Audio = Inverted	Do you want to alarm at a level higher, (normal) or lower, (inverted) than the alarm threshold?
Set Latching	Alarm 1 = Non-latching Alarm 2 = Non-latching Audio = Non-latching	Do you want the alarm to automatically reset? (non-latching) or do you want to manually reset the alarm? (latching)
Alarm Delay	Alarm = 5 seconds	How long do you want to wait until the alarms activate?
Zero Suppression	000 = 0.00% Refer to section 4.5.6	This function is Not Enabled on the Oxygen monitor.
Set Alarm Thresholds	Alarm 1 = 19.5 % Alarm 2 = 18.0 % Audio = 19.5%	At what level do you want to alarm?
Set Alarm Hysteresis	Alarm 1 = 0.0 % Alarm 2 = 0.0 % Audio = 0.0 %	For use when using the O ₂ monitor for control of valves and process. See Section 5.5.9
Sensor Adjustment	No factory default	For use when dynamically gas calibrating the Oxygen monitor to a known span gas. See Section 6.2
Manage Passwords	Factory default is 557	For use when changing the password from factory default to a new password of your choice.

NOTE: The built-in relay settings may be changed by the user in the field. Refer to Section 5.5.2

**** NOTE:** The LED indicators on the front panel are connected directly to the alarm relays.

3: Installation

3.1 Site Requirements

The *Air Check* ✓O₂ monitor enclosure should be mounted in an area free of vibration and electrical noise or interference. If possible, avoid areas with high temperatures or condensing humidity.

The oxygen monitor covers an area of approximately 692 square feet when mounted on a wall and should be placed no more than 21 feet from potential leak sources such as gas lines, gas cylinders, or any areas where a gas leak might be expected to occur. To ensure safety, the maximum distance between two monitors mounted to the same wall, should **not** exceed 30 feet.

WARNING: *The Air Check* ✓ O₂ monitor is not designed for installation in hazardous areas. Consult PureAire for information on enclosures for use in hazardous environments.

3.2 Mounting

3.2.1 Transmitter Enclosure

The *Air Check* ✓O₂ monitor is designed primarily for wall mounting and should be installed at a height convenient for operation, maintenance, and viewing of the instrument display. The following is a drawing of the mounting dimensions.

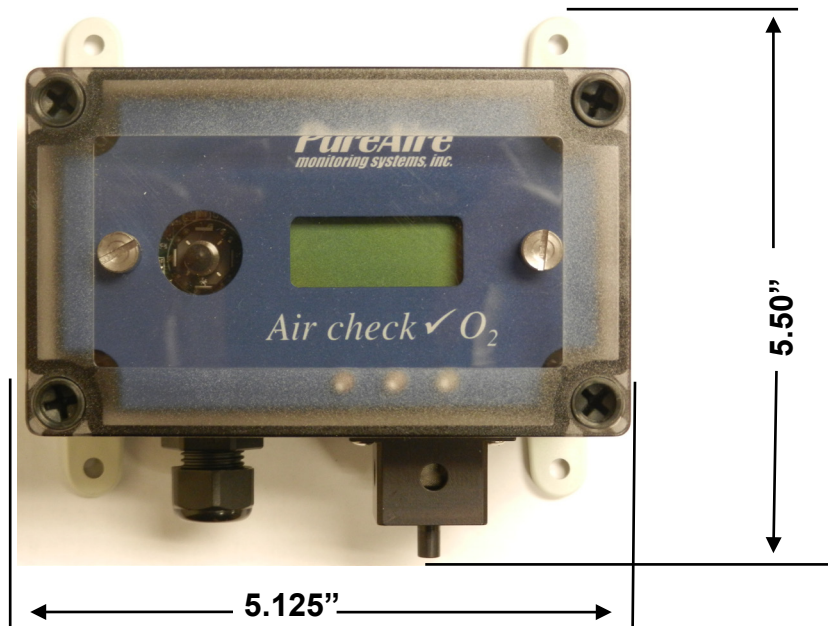

3.2.2 Air Check ✓ O₂ monitor

The transmitter and sensor should be installed in a location where gas leaks are likely to occur or where released gases may accumulate. It should be mounted no closer than 12 inches above floor level. **Airflow within the monitored area, the characteristics of the gas (lighter or heavier than air), and the position of workstations and personnel should all be considered in determining the most suitable installation location.**

3.3 Wiring

The *Air Check* ✓ O₂ monitor requires a single, 3-wire shielded cable for analog output and 24 VDC power input. A three-wire shielded cable; 3-conductor, 18 AWG stranded General Cable E2203S.30.860, or equivalent is recommended for the connection.

The analog out and VDC power in connections are made on the terminal block inside the transmitter housing.

These connections are made as follows:

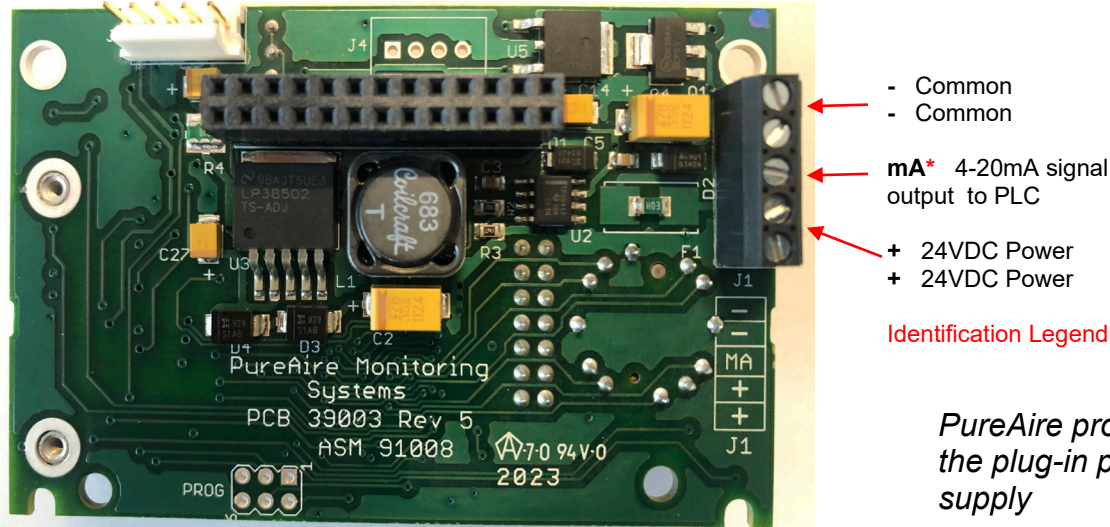

*** Caution: DO NOT connect to a powered current loop receiver. The Air Check Oxygen monitor supplies the current loop power.**

3.4 Initial Startup

Once installation of the gas detector has been completed, it is ready for startup. The following procedures should be performed before putting the instrument into operation:

1. Check the integrity of all wiring.
2. Apply 24 VDC power.

The instrument should now be powered up. Upon power up, the *Air Check* ✓ O₂ monitor LCD displays the PureAire logo and then starts a 4-minute, (240 second) count down as the current to the zirconium oxide O₂ sensor stabilizes. The monitor will output a 4 mA signal during the entire warm-up period. After the countdown, the oxygen sensor will continue to reach its operating temperature for approximately 30 minutes and the reading displayed will slowly increase to ambient. **Do not make any adjustments to the reading until after the monitor has been powered for at least an hour.**

NOTE: When the *Air Check* ✓ O₂ monitor is supplied with an Audio Horn, it will activate momentarily at the completion of the warmup.

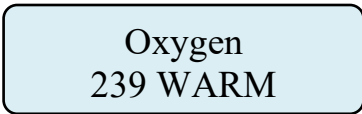

NOTE: The *Air Check* ✓ O₂ monitor's reading may be adjusted to the ambient oxygen level. See section 6.1 for instructions on adjusting.

4: Normal Operation

The *Air Check* O₂ monitor is a single point monitor designed for the continuous detection and measurement of ambient oxygen concentration levels.

4.1 Signal Outputs

The *Air Check* ✓ O₂ monitor outputs a continuous 4-20 mA analog signal proportional to the measured concentration of oxygen. 4 mA represents 0% O₂ and 20 mA represents 95% O₂ which is the full range. In the event of a system fault, a specific factory defined code will be displayed on the local digital display. This code will indicate the exact nature of the system fault.

CAUTION: DO NOT connect to a powered current loop receiver. The Air Check Oxygen monitor supplies the current loop power.

4.2 Instrument Faults

The *Air Check* ✓ O₂ monitor incorporates a number of self-checking features to ensure reliable operation. In the event that a fault condition is detected, the analog output signal is altered: A few common error codes are displayed in the following table:

Condition	Analog Signal
**Supply Voltage Out of Range Fault code 16	Analog output drops to 2 mA
Transmitter cable cut	Analog output drops to 0 mA
O ₂ Cell complete failure Fault Code 128	Analog output drops to 2 mA Fault Relay activates (Available with Relay Option Only)
O ₂ System Warm Up	Analog output drops to 2 mA Fault Relay activates and turns off when system is in the Oxygen operation mode (Available with Relay Option Only)
O ₂ Cell voltage fault Fault Code 64	Analog output drops to 2 mA Fault Relay activates (Available with Relay Option Only)
EEPROM Fault 08	Analog output drops to 2mA

NOTE: All system faults are displayed on the front panel. Each fault has its own specific code to identify the specific problem. Please contact PureAire whenever a fault is displayed.

**** When using your own power supply please ensure that the voltage is regulated to 24VDC +/- 0.5 volts. If the voltage is too low or high you will activate a “Supply Voltage Out of Range fault and disable the monitor.**

NOTE: *If a Fault condition clears itself, (Yellow LED is no longer illuminated)
The Fault message will continue to scroll until manually cleared.*

To clear the fault message, push the joystick down ↓ (- Minus)

4.3 Routine Maintenance Schedule

Continuous gas detection systems depended upon to measure and detect hazardous gas leaks in the workplace requires periodic maintenance to ensure proper operation. The frequency with which this routine maintenance is required depends on the environment. The following table is intended to serve as a general guideline for routine maintenance. The conditions in your particular application, as well as your organization’s maintenance policies, will ultimately determine the best routine maintenance schedule for your equipment. Routine Visual Checks

Items to check	Check for power and proper operation
Condition / status when operating properly	Unit should be outputting a 17.4 mA signal when the oxygen level is at 20.9%. The LCD digital display should also indicate 20.9% O ₂ when the oxygen is at ambient levels.

4.3.2 Recommended Routine Maintenance Schedule

Routine Visual Checks	Every 6 - 12 months
Sensor Verification with nitrogen	Every 6 - 12 months**

** The ambient oxygen level is 20.9%; therefore, under ambient conditions visual verification of the *Air Check* ✓O₂ monitor to 20.9% oxygen is easily performed. The O₂ monitor only requires periodic testing with nitrogen to verify the cells response to low oxygen levels. See Section 5.5.10 for how to make minor adjustments.

4.4 Loss of Power Indicator

In the event the *Air Check* ✓O₂ monitor loses 24VDC power, the 4-20 mA analog output signal drops to 0mA. The LCD display will also display a blank screen.

4.5 Alarm Reset

It the Air *Check* ✓O₂ monitor is supplied with the optional alarm relays, whenever the monitors alarms are activated, the built-in alarm relays, panel mounted LED's and optional audio horn will also activate. When the relay settings are non-latching, the alarm relays, LEDs, and horn will automatically reset. If the relay settings are latching, then a manual reset of the alarms are required. Resetting the alarms can be performed through use of the joystick or through the use of the remote reset function.

Joystick – You must enter the password to enter the reset function. After the password is entered and accepted, push the joystick in; (enter) to reset the alarms.

Remote Reset – See section 1.2.7. The alarm relay board has a two-pin connector for wiring to a remote switch. When connected to a switch, this remote reset will bypass the joystick and a password will not be needed to reset the alarms.

NOTE: The oxygen levels must recover above the alarm thresholds before the horn can be reset from the remote reset switch or joystick.

5: Air Check ✓O₂ Monitor Programming

The *Air Check* ✓O₂ Deficiency Monitor is supplied with user selectable settings to adjust the alarm settings, 4 and 20mA output and minor sensor adjustments. The settings are arranged in menus that are accessed by moving the joystick. To access the menus a factory set password is used.

NOTE: The *Air Check* ✓O₂ Deficiency Monitor will continuously monitor oxygen while accessing the menus. **The alarm, fault relays and mA output are all active and on line while making any changes to the menus.**

5.1 Joystick Operation

The *Air Check* ✓O₂ monitor uses a 4-position joystick with a center pushbutton for selecting menus and changing values. The joystick is programmed to standard protocol as follows:

NOTE: *The joystick has a built-in delay to prevent accidental tampering of the menus. deliberate entries are required.*

CAUTION: *Only qualified personnel should perform programming, maintenance, and sensor verification*

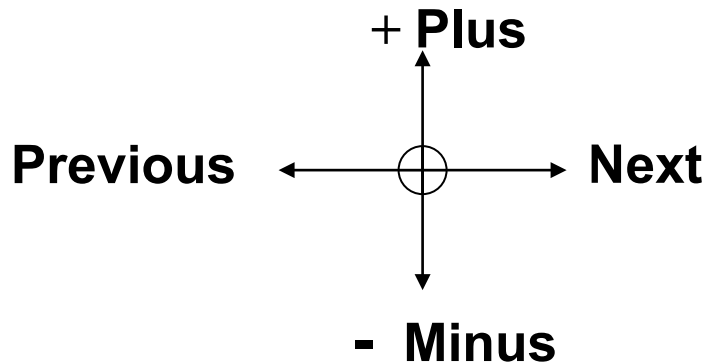

Plus – Pushing the joystick in this direction increases the value

Minus – Pushing the joystick in this direction decreases the value

Next – Pushing the joystick in this direction moves you to the next level of the menu hierarchy.

Previous – Pushing the joystick in this direction takes you out to the last level of menu hierarchy.

Enter – Pushing the joystick directly in the center enters the information into the microprocessor

5.2 Program Flowchart

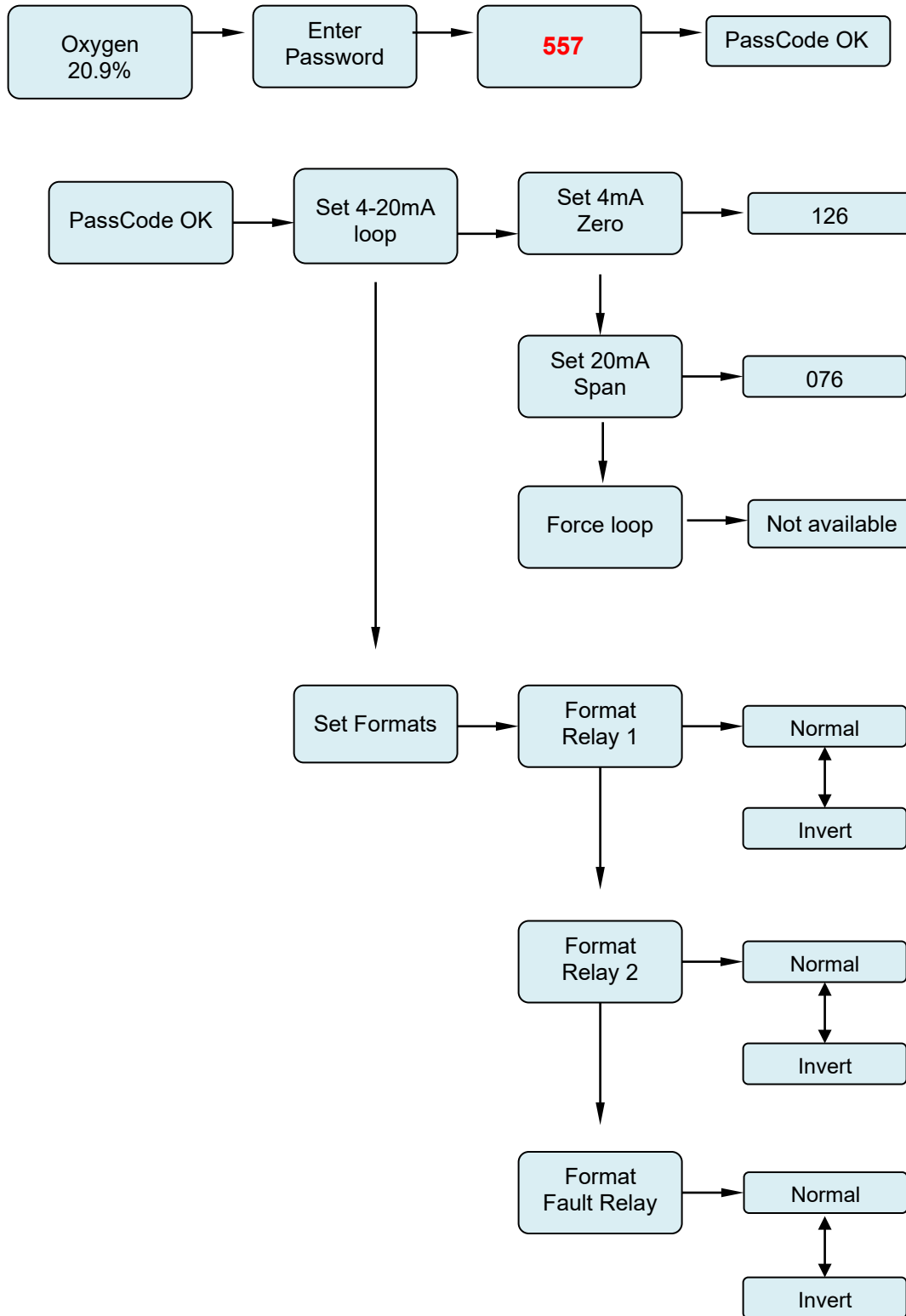

NOTE: All numerical values shown are only examples and are not Factory Defaults

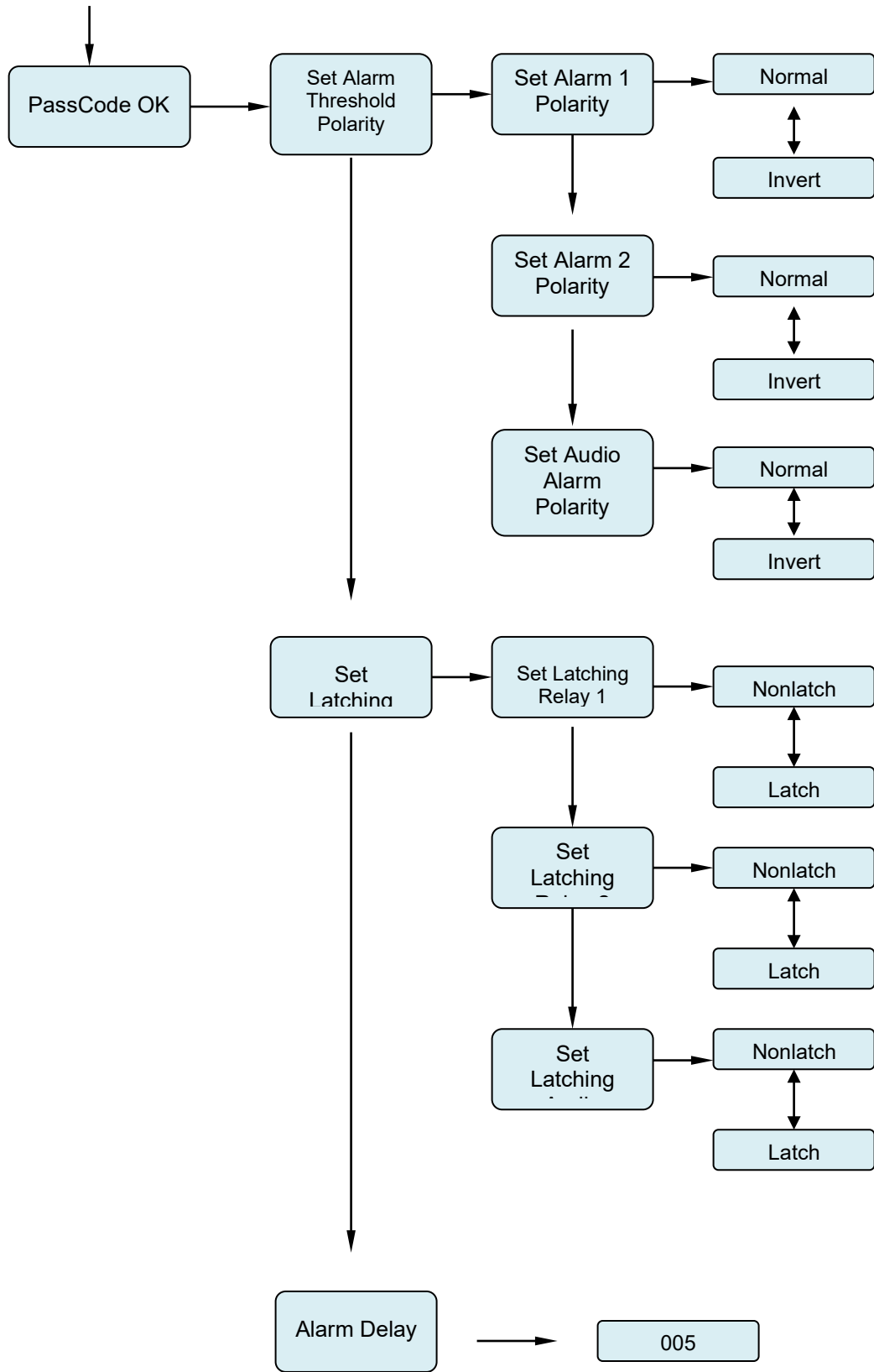

NOTE: All numerical values shown are only examples and are not Factory Defaults

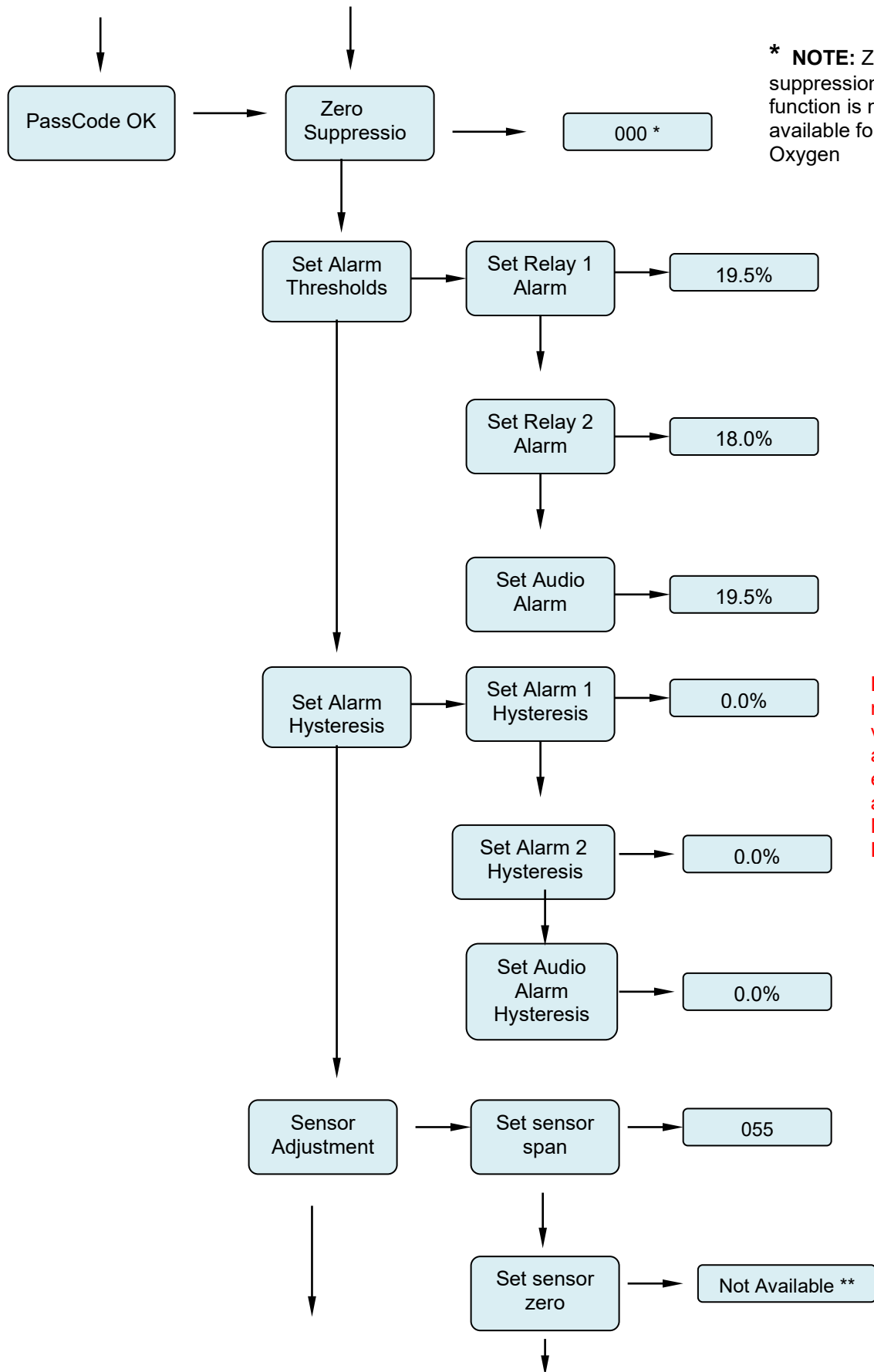

* **NOTE:** Zero suppression function is not available for Oxygen

NOTE: All numerical values shown are only examples and are Not Factory Defaults

5.3 Entering the Password

The Air Check Oxygen monitor is supplied with a factory set password to prevent unauthorized access to the menus. **The Password is 557.** The following explains how to enter the password.

1. Push the joystick once to the right. **Enter Password** will scroll on the first line of the digital display. The second line will still display the current oxygen level.

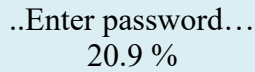

..Enter password...
20.9 %

2. Push the joystick again once more to the right to enter the input screen. **The letter A will appear and flash.**



A
20.9%

NOTE: *The display has characters that start with A through Z and 0 through 9. Pushing the joystick up or down will permit you to scroll through the alphanumeric characters.*

3. Push the joystick up or down to enter the first digit. The display is an alphanumeric display and toggles from A through Z followed by 0 to 9. The character to be entered will flash.



5
20.9%

4. Push the joystick again to the right to select the second entry. Push the joystick up or down to select the second digit. The character being entered will flash and the first character entered will remain lit.



55
20.9%

5. Push the joystick again to the right to select the third entry. Push the joystick up or down to select the third and final digit. The character being entered will flash and the first and second characters entered will remain lit. You are now ready to enter the 3-digit password.



557
20.9%

6. Push the joystick in the center to enter the password. If you entered it correctly the display will scroll **Password OK.**

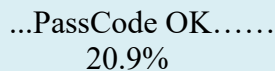

...PassCode OK.....
20.9%

NOTE: **If an incorrect password has been entered, the display will indicate Password Failed. Push the joystick to the left to access the monitoring mode. From this mode you can reenter the password again.**

5.4 Changing the User Password

The Air Check Oxygen monitor is supplied with a factory set password to prevent unauthorized access to the menus. The user can change this password and the following explains how to change the password.

1. Push the joystick down to access the **Manage Passwords Menu**. **Manage Passwords** will scroll on the first line of the digital display. The second line will still display the current oxygen level.

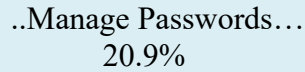

..Manage Passwords...
20.9%

2. Push the joystick to the right to enter the input screen. **Enter New User Password** will scroll on the first line of the digital display

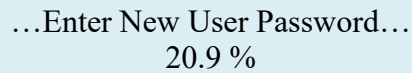

...Enter New User Password...
20.9 %

3. Push the joystick to the right to enter the input screen. **The letter A will appear and flash.**



A
20.9%

NOTE: *The display has characters that start with A through Z and 0 through 9. Pushing the joystick up or down will permit you to scroll through the alphanumeric characters.*

4. Push the joystick up or down to enter the first digit. The display is an alphanumeric display and toggles from A through Z followed by 0 to 9. The character to be entered will flash.



2
20.9%

5. Push the joystick again to the right to select the second entry. Push the joystick up or down to select the second digit. The character being entered will flash and the first character entered will remain lit.



25
20.9%

6. Push the joystick again to the right to select the third entry. Push the joystick up or down to select the third and final digit. The character being entered will flash and the first and second characters entered will remain lit. You are now ready to enter the 3-digit password.

253
20.9%

7. Push the joystick in the center to enter the password. This will display the next command, **Re-Enter New Password**

...Re-Enter New Password...
20.9 %

8. Push the joystick to the right to enter the input screen. **The letter A will appear and flash.**

A
20.9%

9. Push the joystick up or down to enter the first digit. The display is an alphanumeric display and toggles from A through Z followed by 0 to 9. The character to be entered will flash.

2
20.9%

10. Push the joystick again to the right to select the second entry. Push the joystick up or down to select the second digit. The character being entered will flash and the first character entered will remain lit.

25
20.9%

11. Push the joystick again to the right to select the third entry. Push the joystick up or down to select the third and final digit. The character being entered will flash and the first and second characters entered will remain lit. You are now ready to enter the 3-digit password.

253
20.9%

12. Push the joystick in the center to enter the password. If you entered it correctly the display will scroll **“New Password Entry OK”**.

...New Password Entry OK...
20.9%

NOTE: If on the second entry the password entered was different from the first, the display will take you back to the “Re-enter Password Screen”. You will need to repeat steps 2 through 11. If you do not enter the password correctly, the monitor remembers the last password that was properly input.

5.4.1 Enable User Password

This menu permits the user to activate or disable the password function on the Oxygen monitor. Push the joystick down. “**Enable User Password**” will scroll on the first line of the digital display

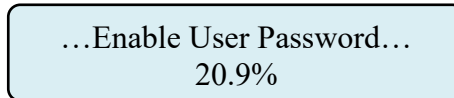

Push the joystick right to display the status. If enabled it will display “**Enabled**”

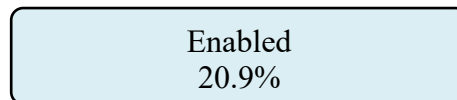

Push the joystick up or down to change the status. Once enabled or disabled is selected, Push the joystick in the center to enter the new status. If correctly entered the display will scroll “**Enable User Password**”

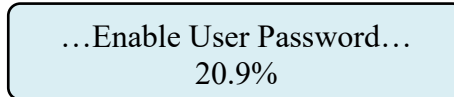

5.4.2 Reset User Password

This menu permits you to reset the password back to **557, as set at the factory.**

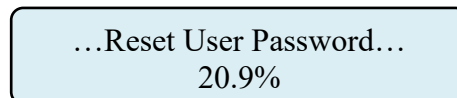

Push the joystick right to display the menu, “**Reset to factory Default**”.

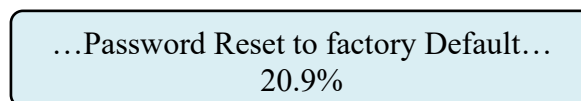

Push the joystick in, (like a doorbell) to reset the password back to 557.
Push the joystick left 4 times to go back to the measuring mode.

NOTE: If you lose your password please contact PureAire with your serial number or DTM number

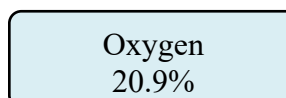

5.5 Entering the Menu

The *Air Check* ✓O₂ monitor is supplied with main menus with sub menus to adjust mA outputs, alarm relay settings, sensor adjustments and zero suppression for toxic and corrosive gas sensor cells.

5.5.1 Set 4-20mA loop

.Set 4-20mA loop..
20.9%

This main menu will permit the adjusting of the 4mA and 20mA output from the Air Check O₂ Monitor. It also provides a function that will send an actual output between 4mA and 20 mA to test any remote control and alarm system attached to the O₂ monitor.

NOTE: *To read the mA output, Air Check O₂ monitor must either be connected to a remote PLC controller or SCADA system. You can also connect the Air Check O₂ monitor to a volt meter to read the mA output. Please consult PureAire for more information.*

From this main menu, pushing the joystick to the right will select the sub menu and the digital display will scroll the following:

..Set 4mA zero...
20.9%

This is the menu at which to adjust the 4mA output being sent from the Air Check O₂ Monitor.

To change this value, push the joystick right to display the 4 mA setting. The display will indicate a value between 0 and 255 counts. Pushing the joystick up increases the value and pushing the joystick down decreases the value. The 4mA output being sent from the Air Check O₂ monitor will change as the number on the digital display changes. Press **ENTER** to accept the value.

255
20.9%

Push the joystick to the left brings you back to the previous Main menu. The digital display will scroll the following:

...Set 4mA zero.....
20.9%

Push the joystick down to access the next sub menu; **Set 20mA Span will scroll.**

...Set 20mA Span...
20.9%

This is the menu at which to adjust the 20mA output being sent from the Air Check O₂ Monitor.

To change this value, push the joystick right to display the 20mA span setting. The display will indicate a value between 0 and 255 counts. Pushing the joystick up increases the value and pushing the joystick down decreases the value. The 20mA output being sent from the Air Check O₂ monitor will change as the number on the digital display changes. Press **ENTER** to accept the value.

255
20.9%

Push the joystick to the left brings you back to the pervious Main menu. The digital display will scroll the following:

...Set 20mA span.....
20.9%

Push the joystick down to access the next sub menu; **Force loop will scroll.**

...Force Loop....
20.9%

NOTE: The Force Loop function is not available on the Air Check O₂ monitor. It was designed for toxic and corrosive gases.

This is the sub menu is only used on PureAire's toxic and corrosive monitors.

...Not Available..
20.9%

Push the joystick to the left brings you back to the pervious menu. The digital display Will scroll the following:

...Force Loop.....
20.9%

NOTE: When adjusting the 4 mA and 20mA settings, the actual reading may quickly switch from your setting and an alternate number. This is a run time indication and is normal.

5.5.2 Set Formats

This is the menu at which to adjust the relay states for the two gas alarm relays and the individual instrument fault relay.

NOTE: *The O₂ system must have the relay module installed to access this menu. If no relay module is installed the display will indicate N/A, (not available)*

Push the joystick down to access the next main menu, **Set Formats**. The display will scroll the following:

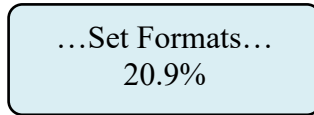

This menu will permit the setting of the two alarm relays and the fault relay settings from normally de-energized state, **Normal**, to normally energized state, **Inverted**.

From this main menu, pushing the joystick to the right will select the sub menu and the digital display will scroll the following:

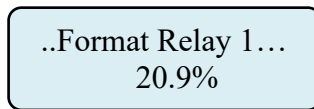

This is the menu at which to adjust the first level alarm relay state on the Air Check O₂ Monitor.

To change this value, push the joystick right to display the relay state. The display will indicate **INVERT**. Pushing the joystick down will change the relay state from **INVERT** to **NORMAL**. Press **ENTER** to accept the value.

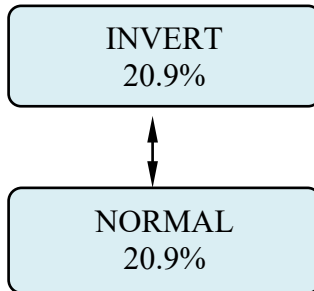

After entering the relay state, the display will default back to the Set Formats menu. The display will scroll the following:

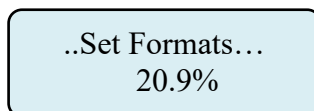

From this main menu, pushing the joystick to the right will select the sub menu and the digital display will scroll the following:

..Format Relay 1...
20.9%

Push the joystick down to access the next main menu, **Set Formats**. The display will scroll the following:

... Format Relay 2..
20.9%

This is the menu at which to adjust the second level alarm relay state on the Air Check O₂ Monitor.

To change this value, push the joystick right to display the relay state. The display will indicate **INVERT**. Pushing the joystick down will change the relay state from **INVERT** to **NORMAL**. Press **ENTER** to accept the value.

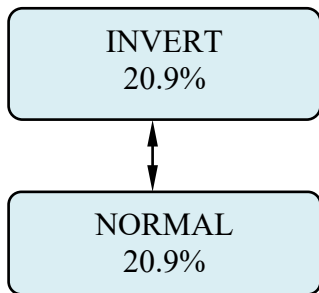

After entering the relay state, the display will default back to the Set Formats menu. The display will scroll the following:

..Set Format ...
20.9%

From this main menu, pushing the joystick to the right will select the sub menu and the digital display will scroll the following:

..Format Relay 1...
20.9%

Push the joystick twice to select the fault relay to be adjusted. The display will scroll; **Format Fault Relay**.

..Format Fault Relay...
20.9%

This is the menu at which to adjust the fault alarm relay state on the Air Check O₂ Monitor.

To change this value, push the joystick right to display the relay state. The display will indicate **INVERT**. Pushing the joystick down will change the relay state from **INVERT** to **NORMAL**. Press **ENTER** to accept the value.

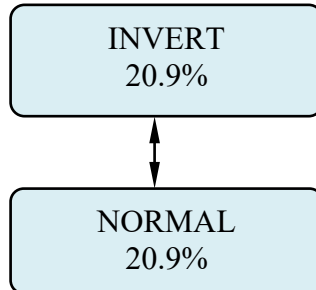

After entering the relay state, the display will default back to the Set Formats menu. The display will scroll the following:

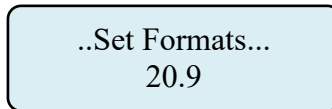

5.5.3 Set Alarm Threshold Polarity

Alarm Threshold Polarity determines if an alarm concentration is set above or below a threshold value. For example, if an alarm of 19.0% for Oxygen is selected, the Alarm Threshold Polarity must be set to **Invert** for the monitors alarm to activate when the reading goes below 19.0%. For toxic and corrosive gases selecting a **Normal** setting for the Alarm Threshold Polarity means that the system will alarm when the gas concentration exceeds, goes above, an alarm set point. This menu will permit the selection of the alarm polarity. To access this menu from the "Set Formats" menu, push the joystick down to display the **Set Alarm Threshold Polarity** adjustment menu. This will scroll on the digital display.

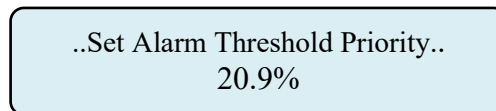

Push the joystick right to access the first sub menu; **Set Alarm 1 Polarity** will scroll on the display. This is the menu at which to adjust the first level alarm polarity state on the Air Check O₂ Monitor.

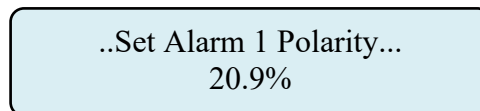

To change this value, push the joystick right to display the relay state. The display will indicate **INVERT**. Pushing the joystick down will change the relay state from **INVERT** to **NORMAL**. Press **ENTER** to accept the value.

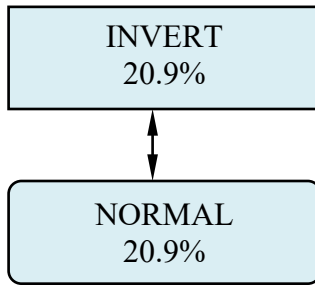

After entering the relay state, the display will default back to the Set Alarm 1 Polarity menu. The display will scroll the following:

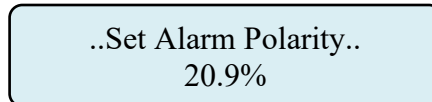

Push the joystick down to access the next sub menu; **Set Alarm 2 Polarity** will scroll on the display. This is the menu at which to adjust the second level alarm polarity state on the Air Check O₂ Monitor.

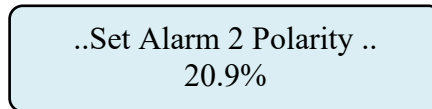

To change this value, push the joystick right to display the relay state. The display will indicate **INVERT**. Pushing the joystick down will change the relay state from **INVERT** to **NORMAL**. Press **ENTER** to accept the value.

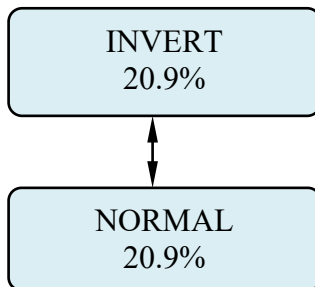

After entering the relay state, the display will default back to the Set Relay 2 Alarm Threshold menu. The display will scroll the following:

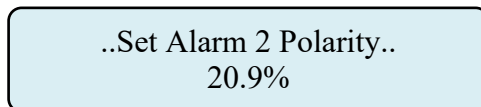

Push the joystick down to access the next sub menu; **Set Audio Alarm Polarity** will scroll on the display. This is the menu at which to adjust the second level alarm polarity state on the Air Check O₂ Monitor.

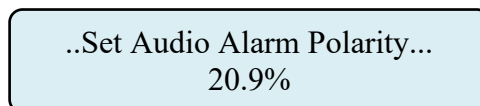

NOTE: The O₂ system must have the audio alarm option module installed to access this menu. If this option is installed the display will indicate N/A, (not available)

NOTE: The built-in horn is designed to operate in only one alarm mode. It will activate in either a decreasing alarm or an increasing alarm mode only. The horn activation is immediate any time an alarm threshold is exceeded.

To change this value, push the joystick right to display the relay state. The display will indicate **INVERT**. Pushing the joystick down will change the relay state from **INVERT** to **NORMAL**. Press **ENTER** to accept the value.

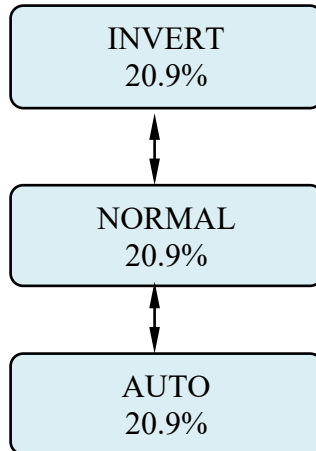

Auto Mode - The auto mode is used when you wish the horn to activate at the same time the relays activate. In the Normal or Inverted Mode, the horn immediately activates any time the alarm thresholds are exceeded. To activate the horn when the relays activate, choose the **AUTO** mode.

After entering the relay state, the display will default back to the **Set Audio Alarm Polarity** menu. The display will scroll the following:

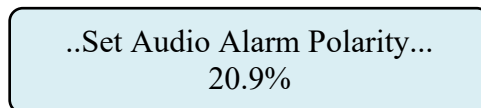

5.5.4 Set Latching

This is the menu at which to adjust the relay alarm state for the two gas alarm relays and the individual instrument fault relay. The selection permits setting the relays to a latching or non-latching state. In a latching state, the relay will remain activated until the user manually selects the Enter Key. In a non-latching state, the alarm relay will automatically reset once the gas concentration has returned to 20.9% for oxygen.

NOTE: *The O₂ system must have the relay module installed to access this menu. If no relay module is installed the display will indicate N/A, (not available)*

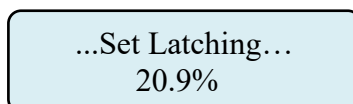

This menu will permit the setting of the two alarm relays and the fault relay settings from a latching to a non latching state when they are activated.

From this main menu, pushing the joystick to the right will select the sub menu and the digital display will scroll the following:

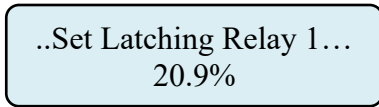

This is the menu at which to adjust the first level alarm relay state on the Air Check O₂ Monitor.

To change this value, push the joystick right to display the relay state. The display will indicate **LATCH**. Pushing the joystick down will change the relay state from LATCHING to NON-LATCHING. Press **ENTER** to accept the value.

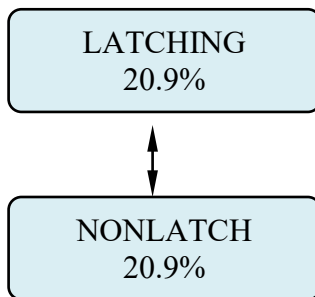

After entering the relay state, the display will default back to the **Set Latching** menu. The display will scroll the following:

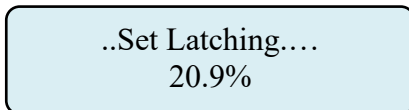

From this main menu, pushing the joystick to the right will select the sub menu and the digital display will scroll the following:

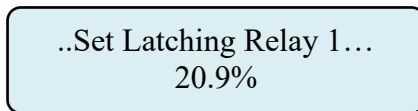

Push the joystick down to select the next relay to be adjusted. The display will scroll the following, **Set Latching Relay 2**.

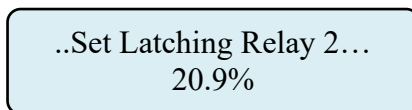

This is the menu at which to adjust the second level alarm relay state on the Air Check O₂ Monitor.

To change this value, push the joystick right to display the relay state. The display will indicate **LATCHING**. Pushing the joystick down will change the relay state from LATCHING to NONLATCH. Press **ENTER** to accept the value.

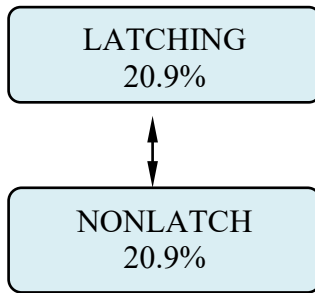

After entering the relay state, the display will default back to the **Set Latching** menu. The display will scroll the following:

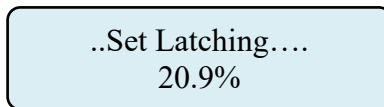

From this main menu, pushing the joystick to the right will select the sub menu and the digital display will scroll the following:

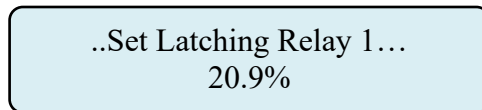

Push the joystick twice to select the Audio Alarm relay to be adjusted. The display will scroll; **Set Latching Audio Alarm.**

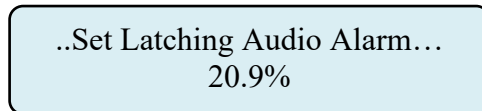

This is the menu at which to adjust the Audio alarm relay state on the Air Check O₂ Monitor.

NOTE: *The O₂ system must have the audio alarm option module installed to access this menu. If this option is installed the display will indicate N/A, (not available)*

To change this value, push the joystick right to display the relay state. The display will indicate **LATCHING**. Pushing the joystick down will change the relay state from LATCHING to NONLATCH. Press **ENTER** to accept the value.

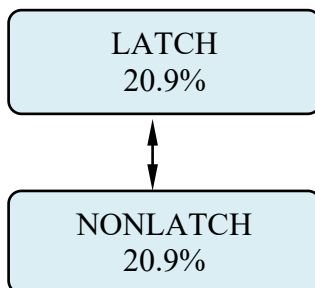

After entering the fault relay state, the display will default back to the **Set Latching** menu. The display will indicate the following:

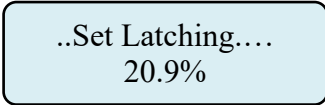

5.5.5 Resetting a Latching Alarm

To reset a latching alarm relay, you must enter the password correctly and then push the joystick down to enter the reset command. The Oxygen monitor also has an internal 2-pin terminal block for connecting a remote reset switch. (See Alarm Relay board, section 1.2.7)

5.5.6 Set Alarm Delay

Push the joystick down to access the next main menu, **Alarm Delay**. The display will scroll the following:

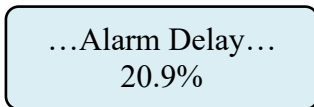

This is the amount of time an alarm level concentration of oxygen must be present before the instrument's gas concentration alarm(s) will be activated. This menu will permit setting a user selected time delay for activating alarm relays 1 and 2. You can select from 0 seconds up to 255 seconds after an alarm level has been exceeded before the alarm relays to activate.

To change this value, push the joystick right to display the time screen. The display will indicate a value between 0 and 255 seconds. Pushing the joystick up increases the value and pushing the joystick down decreases the value. Press **ENTER** to accept the value.

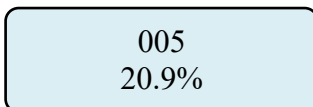

After entering the alarm delay, the display will default back to the Alarm Delay menu and the display will scroll the following:

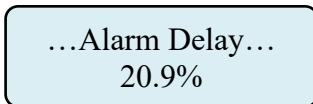

NOTE: *The alarm delay is only available for alarms 1 and 2. There is no delay for the fault relay. Any system fault will immediately activate the Fault Relay.*

5.5.7 Set Zero Suppression

This function not used on the Oxygen monitor. It is only used to decrease the sensitivity of selected gas sensors. Although the menu permits the changing of settings, it is totally disabled in the Oxygen monitor. The factory default is set at 000.

NOTE: This function is not available on the Air Check Oxygen monitor.

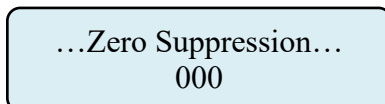

5.5.8 Set Alarm Thresholds

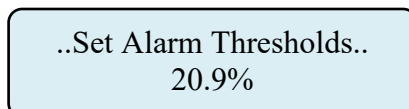

This main menu will permit adjusting the oxygen concentration percentage that will activate alarm levels 1 and 2. If the Audio alarm output module is installed, it will also permit setting the level at which the audio alarm will activate.

NOTE: *To activate the audio alarm, the AirCheck O₂ monitor must have the audio alarm option.*

From this main menu, pushing the joystick to the right will select the first sub menu and the digital display will scroll the following: **Set Relay 1 Alarm Threshold.**

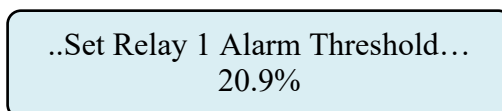

This is the gas concentration at which the instrument's first level alarm will be activated. To change the displayed value, push the joystick to the right to display the first level alarm setting. The display will indicate a value between 00.0% and 25.5%.

Pushing the joystick up increases the value and pushing the joystick down decreases the value. Press **ENTER** to accept the value.

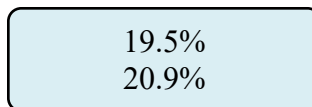

After entering the relay state, the display will default back to the **Set Relay 1 Alarm Threshold** Menu. The display will scroll the following:

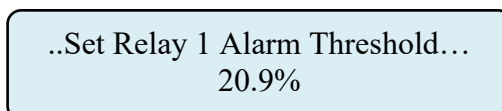

Push the joystick down to access the next sub menu; **Set Relay 2 Alarm Threshold**, will scroll on the digital display.

..Set Relay 2 Alarm Threshold...
20.9%

This is the gas concentration at which the instrument's second level alarm will be activated. To change the displayed value, push the joystick to the right to display the second level alarm setting. The display will indicate a value between 00.0% and 25.5%.

Pushing the joystick up increases the value and pushing the joystick down decreases the value. Press **ENTER** to accept the value.

18.0%
20.9%

After entering the relay state, the display will default back to the **Set Relay 2 Alarm Threshold** Menu. The display will scroll the following:

..Set Relay 2 Alarm Threshold...
20.9%

Push the joystick down to access the next sub menu; **Set Audio Alarm Threshold**, will scroll on the digital display.

..Set Audio Alarm Threshold...
20.9%

This is the gas concentration at which the instrument's audio alarm will be activated. To change the displayed value, push the joystick to the right to display the second level alarm setting. The display will indicate a value between 00.0% and 25.5%.

Pushing the joystick up increases the value and pushing the joystick down decreases the value. Press **ENTER** to accept the value.

NOTE: *The O₂ system must have the audio alarm option module installed to access this menu. If this option is installed the display will indicate N/A, (not available)*

19.5%
20.9%

NOTE: *The audio can be set into only one alarm level. You can choose between alarm level 1 or alarm level 2 or set a completely different setting.*

After entering the relay state, the display will default back to the **Set Audio Threshold** Menu. The display will scroll the following:

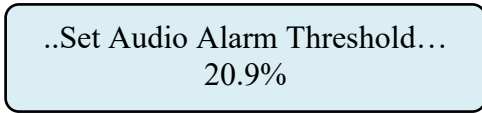

5.5.9 Set Alarm Hysteresis

PureAire’s oxygen monitor may be used as a control system. When used to regulate oxygen levels the need of a dead band, “hysteresis” may be required for the alarm relays. This menu will permit the setting of the alarm hysteresis to a desired concentration of Oxygen. When using hysteresis, the alarm set point now becomes an average alarm setting for an action to occur. When adding the hysteresis value to the alarm set point, this then defines the alarm and dead band for an action to occur.

For example, if you require a valve to close at 14.9% oxygen level and to reopen again at 15.5% oxygen level, you would set the Alarm Threshold at 15.2% and set the hysteresis value at 0.3%.

Average Alarm set point = 15.2% - Hysteresis 0.3% = 14.9%, Valve Off
Average Alarm set point = 15.2% + Hysteresis 0.3% = 15.5%, Valve On

To access this menu, push the joystick down to display the **Set Alarm Hysteresis** menu. This will scroll on the digital display.

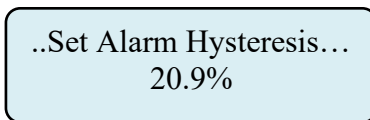

Push the joystick right to access the **Set Alarm 1 Hysteresis**. Pushing the joystick again to the right will display a value 0.0%, (factory default). Pushing the joystick up increases the percentage up to a maximum value of 2.5%. Adjust the digital display until the desired hysteresis value is selected.

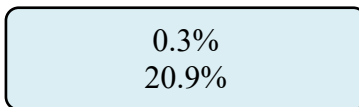

Press **ENTER** to accept this value. The digital display will revert back to **Set Alarm 1 Hysteresis**.

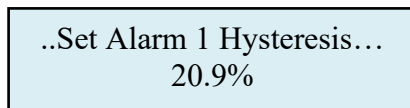

Push the joystick down to access the next sub menu; **Set Alarm 2 Hysteresis** will scroll on the digital display. Pushing the joystick again to the right will display a value 0.0%. Pushing the joystick up increases the percentage up to a maximum value of 2.5%. Adjust the digital display until the desired hysteresis value is selected.

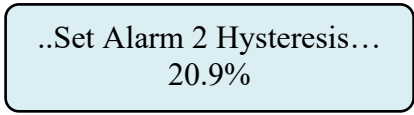

Press **ENTER** to accept this value. The digital display will revert to **Set Alarm 2 Hysteresis**.

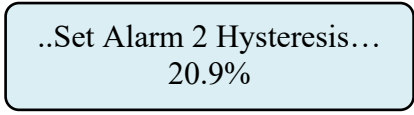

Push the joystick down to access the next sub menu; **Set Alarm Audio Hysteresis** will scroll on the digital display. Pushing the joystick again to the right will display a value 0.0%. Pushing the joystick up increases the percentage up to a maximum value of 2.5%. Adjust the digital display until the desired hysteresis value is selected.

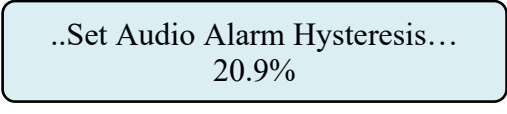

5.5.10 Set Sensor Adjust

This menu will permit fine-tuning of the oxygen readout to a known concentration of Oxygen. It is recommended to adjust the oxygen display to ambient oxygen levels of 20.9%. To access this menu, push the joystick down to display the **Sensor Adjustment** menu. This will scroll on the digital display.

NOTE: It is recommended to warm up the Air Check Oxygen monitor for two hours before making any adjustments to the sensor.

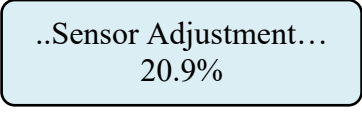

Push the joystick right to access the first sub menu; **Set Sensor Span** will scroll on the display. This is the menu that will permit fine adjustment of the ambient oxygen reading to 20.9%.

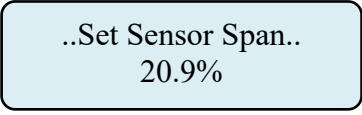

Push the joystick right to access the sensor span. The display will indicate a value between 0 and 255 counts. Pushing the joystick up increases the counts and decreases the percent oxygen value displayed on the Air Check. Pushing the joystick down

decreases the counts and increases the oxygen value displayed on the Air Check. As the counts increase and decrease the percent oxygen displayed will also increase and decrease. Adjust the digital display until 20.9% +/- 0.1% is displayed. The actual oxygen reading will fluctuate from 20.8% to 21.0%.

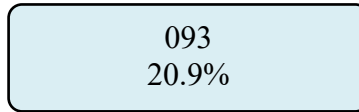

Press **ENTER** to accept this value. The digital display will revert to **Set Sensor Span.**

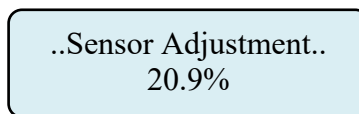
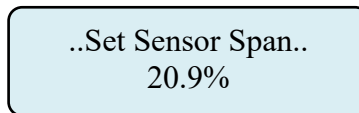

Press the joystick to the left to revert back to the **Sensor Adjustment** menu.

NOTE: The "Set Module Zero" menu is not available for the Oxygen monitor. This menu was designed for PureAire toxic and corrosive gas monitors. When selected, nothing will happen. Push the joystick Left to leave this menu.

5.5.11 Main Operation Mode

To select the main menu from any sub menu, push the joystick left until the Main Me appears. The digital display will indicate the following:

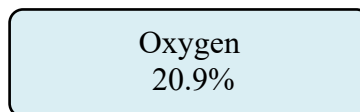

6: Maintenance & Sensor Verification

Only qualified personnel should perform maintenance and sensor verification

6.1 Sensor Verification

The earth is a stable source of calibrated oxygen at 20.9%, therefore under ambient conditions you can perform a visual verification of the **Air Check** ✓ O₂ monitor to verify its reading at 20.9%. As the oxygen sensor ages over time, it may require a slight adjustment to 20.9%. The O₂ monitor only requires periodic testing with nitrogen to verify the cells response to 0% oxygen levels and, if needed, a slight annual adjustment of the sensor span to 20.9%.

6.1.1 Sensor Verification Gas

For testing the **Air Check** ✓ O₂ monitor, PureAire recommends the use of nitrogen. This can be purchased directly from PureAire or from your gas supplier.

6.1.2 Sensor Verification Equipment

This can be purchased directly from PureAire or from your gas supplier.

Part Number	Description	Quantity
94004-Fixed Rate Regulator Calibration Kit	Nitrogen 103 liter cylinder, 99% Oxygen 103 liter cylinder, 8% Fixed Rate Regulator, C-10, 0.5lt/min 2ft-1/8"ID 1/2"OD Tubing Carrying Case	1 each
94019	Ultra Zero Grade Air 103 liter cylinder, C-10	1

For Calibration Kit replacement items, please contact PureAire or visit www.PureAireMonitoring.com

NOTE: If the instrument is connected to a controller, set the controller to the standby mode to avoid accidental alarms.

NOTE: If your safety protocol requires, you may subject the Air Check monitor to different concentrations of oxygen span gas.

6.2 Sensor Verification Procedure

CAUTION: *Be sure to observe all safety guidelines when generating and using nitrogen.*

Under ambient non-oxygen deficient environments, **Air Check ✓ O₂** monitor will indicate a display reading of 20.9%. As the sensor ages, the reading may decrease in value. The following procedure should be used to adjust the reading to 20.9%.

It is recommended to verify and adjust the sensor span to ambient 20.9% annually.

- 1)
- 2) Ensure that the **Air Check ✓ O₂** monitor is in a clean non-oxygen deficient environment. *(It is also permissible to challenge the monitor to a cylinder of zero air if the monitor is in an oxygen deficient environment)*
- 3) Enter the password. **Refer to Section 5.3**
- 3) Select the **Sensor Adjust** menu.

This menu will permit fine-tuning of the oxygen readout to a known concentration of Oxygen. It is recommended to adjust the oxygen display to ambient oxygen levels of 20.9%. To access this menu, push the joystick down to display the **Sensor Adjustment** menu. This will scroll on the digital display.

NOTE: It is recommended to warm up the Air Check Oxygen monitor for two hours before making any adjustments to the sensor.

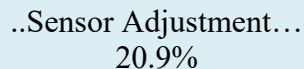

..Sensor Adjustment...
20.9%

Push the joystick right to access the first sub menu; **Set Sensor Span** will scroll on the display. This is the menu that will permit fine adjustment of the ambient oxygen reading to 20.9%.

Push the joystick right to access the first sub menu; **Set Sensor Span** will scroll on the display. This is the menu that will permit fine adjustment of the ambient oxygen reading to 20.9%.

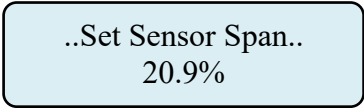

..Set Sensor Span..
20.9%

Push the joystick right to access the sensor span. The display will indicate a value between 0 and 255 counts. Pushing the joystick up increases the counts and decreases the percent oxygen value displayed on the Air Check. Pushing the joystick down decreases the counts and increases the oxygen value displayed on the Air Check. As the counts increase and decrease the percent oxygen displayed will also increase and decrease. Adjust the digital display until 20.9% + / - 0.2% is displayed.

093
20.9%

Press **ENTER** to accept this value. The digital display will revert to **Set Sensor Span**.

..Set Sensor Span..
20.9%

Press the joystick to the left to revert to the **Sensor Adjustment** menu.

...Sensor adjustment..
20.9%

6.2.1 Sensor Verification to Nitrogen

PureAire recommends challenging the O₂ monitor with nitrogen every 6 to 12 months. The sensor protector has a ¼" male tube fitting designed for connecting sample tubing from a Nitrogen cylinder. Expose the O₂ cell to N₂ at a flow rate of 500 cc/min. The reading will drop off to 1% or below in less than one minute when the O₂ sensor is exposed to pure N₂. The system will recover to 20.9% when the nitrogen is removed.

NOTE: The Sensor Protector has four air relief holes that will prevent the complete exposure of nitrogen to the oxygen sensor. To see a true zero oxygen level, the entire Air Check ✓ O₂ monitor needs be completely immersed into a zero oxygen environment. Covering the holes will help to prevent dilution of the span gas to ambient air.

6.2.2 Sensor Verification to a known concentration of Oxygen

When testing the O₂ monitor to a known concentration of oxygen, the sensor inlet has a ¼" compression tube fitting designed for connecting the sample tubing. You can connect ¼" OD sample tubing from a cylinder filled with Zero Grade air directly to the sensor protector and expose the O₂ cell directly at a flow rate of 500 cc/min.

Expose the monitor for 1 minute and then adjust the reading to 20.9% when using Zero Grade air. Turn off the regulator and remove the Zero grade air from the monitor. The final reading should be within ± 0.3% of the span gas concentration.

To see the exact span gas concentration the entire Air Check O₂ monitor needs to be completely immersed into the span gas environment.

NOTE: The Oxygen monitor should be tested in an upright position to allow the span gas to fully saturate the sensor cell.

CAUTION: For best results, the Oxygen monitor should be protected from wind and high airflow when gas calibrating with test gas.

NOTE: To see a true zero, the entire Air Check ✓ O₂ monitor needs to be completely immersed into a zero oxygen environment.

**O₂ monitor
Connected to gas cylinder**



7.0 Appendix

CONTACTOR/FAN CONNECTION

EXTERNAL RELAY FOR LOADS >2A

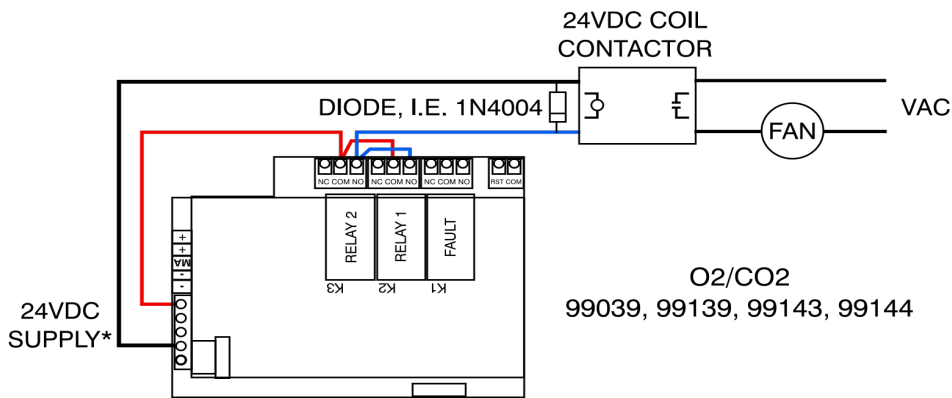
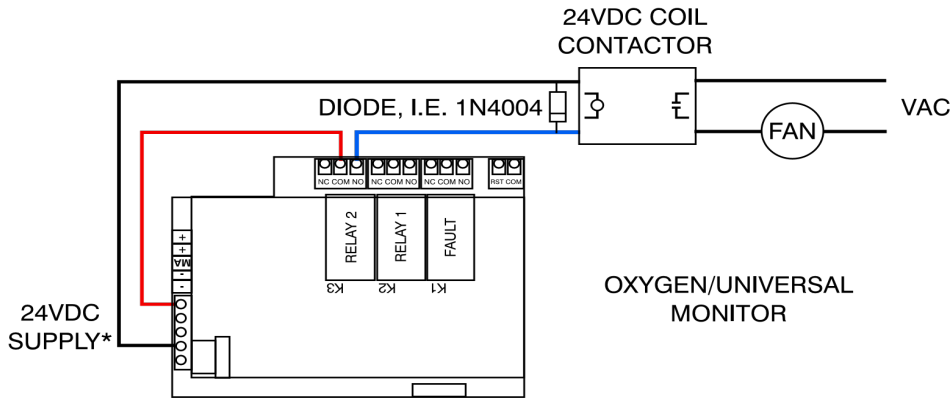

DIAGRAMS FOR 99016, 99029, 99129, 99028, 99145, 99097, 99141, 99035, 99128, 99020, 99045, UNLESS NOTED.

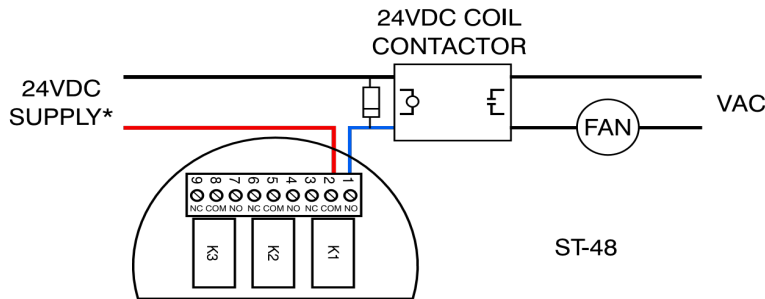

NOTE: ENSURE CONTACTOR CHOSEN HAS CORRECT COIL VOLTAGE AND IS CURRENT-RATED FOR YOUR LOAD

* OK TO USE EXTERNAL SUPPLY AS LONG AS VOLTAGE IS 24VDC/AC OR LESS

How to convert 4-20mA current output to a 1-5 VDC voltage output

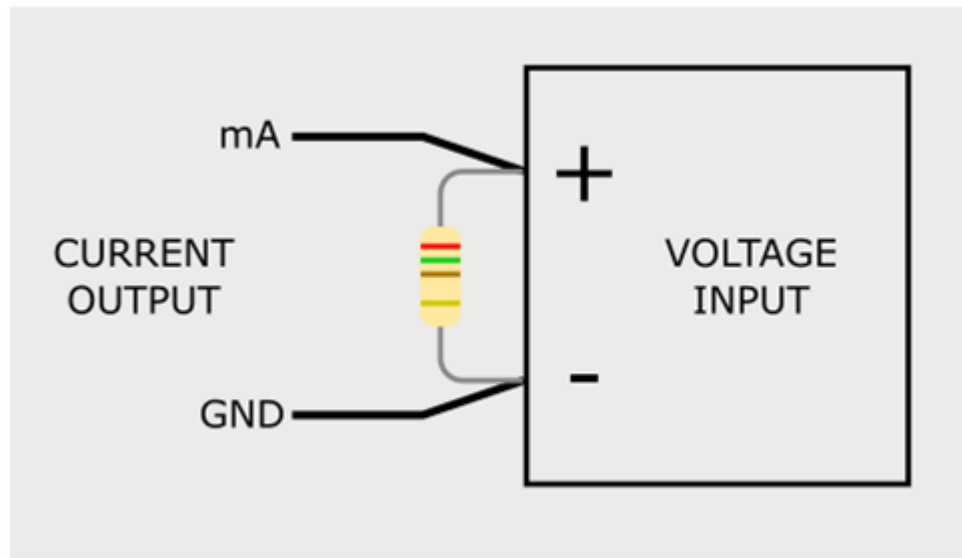
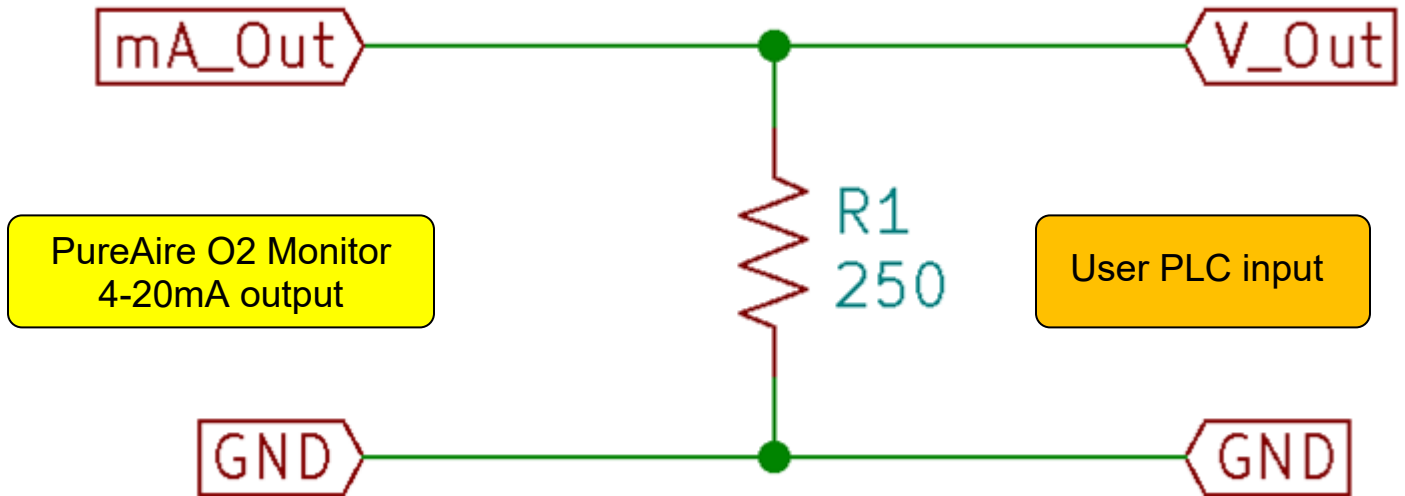

Attach 250-ohm resistor to the PLC or device input