



Air Check Advantage Methyl Bromide Monitor

Instruction Manual

Part Number 99088 (0-10ppm)

99072 (0-20ppm)



PureAire Monitoring Systems, Inc.

1140 Ensell Road

Lake Zurich, IL. 60047

Phone: 847-726-6000

Fax: 847-726-6051

Toll-Free: 888-788-8050

E-mail: info@pureaire.net

Rev 4.09 August 2023

Welcome to PureAire Monitoring Systems

I'd like to thank you for investing in our continuous life safety and process control toxic gas monitoring systems.

PureAire offers an unbeatable combination of experience and innovation in solving the safety and environmental needs of our customers. We are capable of providing small systems of a few points to a total multi-point turnkey computerized package.

PureAire's proprietary sensor cell technology and state-of-the-art electronics are designed to interface with the latest distributive or PLC based control systems. We believe that our experience, innovative products, and commitment to service will satisfy your specific monitoring needs now and in the future.

Our growth is a result of our total commitment to supporting our customers. We are available 24 hours a day, 7 days a week to help you when you need us. Our 24 hour Emergency phone number is 224-443-5445. We can provide field service, preventative maintenance programs and training to your technicians in the operation of our equipment. Our goal is to provide the best after sale service and support in the industry. That is just one way PureAire takes that extra step to ensure your complete satisfaction.

Thank you again for investing in PureAire Monitoring Systems for your monitoring needs and I'm proud to welcome you to our family of valued and satisfied customers.

Sincerely,

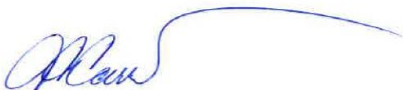

**Albert A. Carrino
President**

Read Before Operating

This gas monitoring system has been designed to provide long-term reliable performance. We recommend the following basic precautions while installing, operating, and maintaining this device.

- Read this “Guide to Operation and Installation” carefully. Qualified personnel should perform installation, maintenance, calibration and testing only.

- Check if the power supply matches the specifications given in this guide and ensure that the system has been connected properly. This monitor must be powered by a regulated 24VDC power supply.
Please insure the proper polarity. Reversing the polarity will damage the fuse on the drive PCB.

- **After power up, please let the system equilibrate a few hours before making any adjustments.**

- The methyl bromide monitor is designed for safety monitoring where normal use is defined as zero gas concentration with an occasional excursion. If the monitor is continuously exposed to methyl bromide or if the monitor is exposed to very high short term gas concentrations, it will require more frequent sensor cell recharges, and complete pyrolizer filament and pump replacement.

- **Exposing the methyl bromide monitor to continuous levels of sulfur dioxide (SO₂) from produce in cold storage facilities will shorten the life of the gas sensor. This may require the need for annual gas sensor replacement.**

- **The pyrolizer filament is fragile and must never be disturbed once inside the pyro tube. Never twist the filament inside the pyro tube.**

This system has a built-in pyrolizer. The pyrolizer insulation temperature can reach 150 F and can cause burns if touched. Use Caution when working near the pyrolizer.

Table of Contents

| | |
|--|-----------|
| 1: Introduction | 5 |
| 1.1 Component Identification..... | 6 |
| 2: Specifications | 11 |
| 2.1 Performance Specifications..... | 11 |
| 2.2 Gas Detection System..... | 11 |
| 2.3 Signal Outputs..... | 12 |
| 2.4 Electrical Requirements | 12 |
| 2.5 Physical Characteristics | 12 |
| 2.6 Air Check Methyl Bromide Default Settings..... | 13 |
| 3: Installation | 14 |
| 3.1 Site Requirements | 14 |
| 3.2 Mounting..... | 14 |
| 3.3 Sensor Installation..... | 14 |
| 3.4 Wiring | 15 |
| 3.5 Initial Startup | 16 |
| 4: Air Check Methyl Bromide Programming | 17 |
| 4.1 Control Panel Overview..... | 17 |
| 4.2 Joystick Operation | 17 |
| 4.3 Program Flow Chart..... | 18 |
| 4.4 Entering the Password..... | 22 |
| 4.5 Changing the User Password | 23 |
| 4.6 Entering the Menus | 26 |
| 5: Maintenance & Calibration | 37 |
| 5.1 Routine Maintenance Schedule..... | 37 |
| 5.2 Loss of Power Indication | 37 |
| 5.3 Sensor Cell Removal and Installation..... | 38 |
| 5.4 Electrolyte Replacement | 39 |
| 5.5 System Calibration..... | 43 |
| 6: Appendix | 47 |

1: Introduction

The Air Check Methyl Bromide Monitor is a compact extractive gas sampling system designed for the continuous detection and measurement of toxic gas leaks. It is capable of sampling over distances of up to 100 feet (33 meters).

The Air Check is a single point monitoring system built into an a Nema 4x water resistant housing that may be wall mounted and is designed to require as little space for installation as possible.

The system has the following features:

- 24 VDC operation
- Built-in pyrolizer
- Integral digitally controlled sampling pump and flow system
- Local digital display
- User selectable dual level alarm and system fault relays
- 4-20 mA output
- Renewable long life electrochemical sensor cell
- Supervised electronics monitors sensor, pyrolizer and sample pump

➔ **NOTE: The Air Check Methyl Bromide enclosure is NOT rated for Class 1, Division 1 Groups B, C & D**

1.1 Component Identification

1.1.1 Overall System Composition

The Air Check Methyl Bromide Monitor may be integrated into the overall hazardous gas monitoring system. As a result, it may be remotely located for the monitoring of process areas and other environments where access to the instrument for maintenance or service may be restricted. It may also be used as a stand-alone detection system.



Front Cover— This permits access to the inside of the sample and control system.

Mounting Tabs— Adjustable feet designed to connect the methyl bromide enclosure to walls or another solid surface. There is one on each corner of the enclosure.

Cover Fastening Screws— Captive Philips head plastic screws used to fasten the front cover to the base of the methyl bromide monitor. There is one on each corner of the front cover.

NOTE: Please do not over tighten the screws as the Phillips head will strip.

Cable Strain Relief — This is the opening in the transmitter housing for connecting the 4-20 mA output, 24 VDC power cable, and alarm relay wiring.

Sample Inlet — This serves as the connection for the incoming sample line.

Sample exhaust — This serves as the connection for the sample exhaust line.

Cooling Fan — This fan pushes air into the case for cooling. It exhausts on the top right side of the case

1.1.2 Front View Control Panel

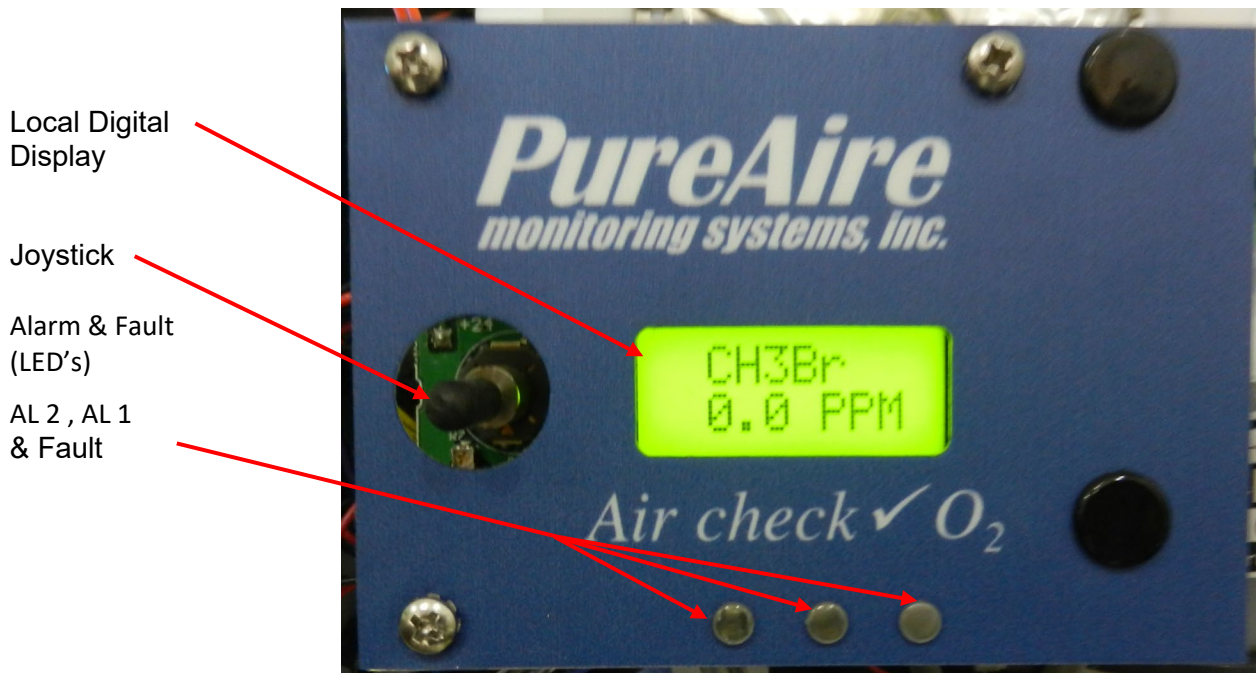

1. **Local Digital Display** — During normal operation, displays the name and concentration of the target gas. Also displays alarm messages and programming/calibration menus and information.
 2. **Joystick** — Used for selecting and adjusting the built-in menus for alarm threshold settings, relay state, alarm delay etc.
 3. **Alarm & Fault LED's** — These LED's illuminate when a gas concentration alarm or instrument fault is detected.
- ➔ **NOTE** – *The flow rate is factory set and is continuously regulated via a built-in flow sensor. Flow rate is factory set for sampling distances up to 100 feet. Field adjustment cannot be performed.*

1.1.3 Internal View

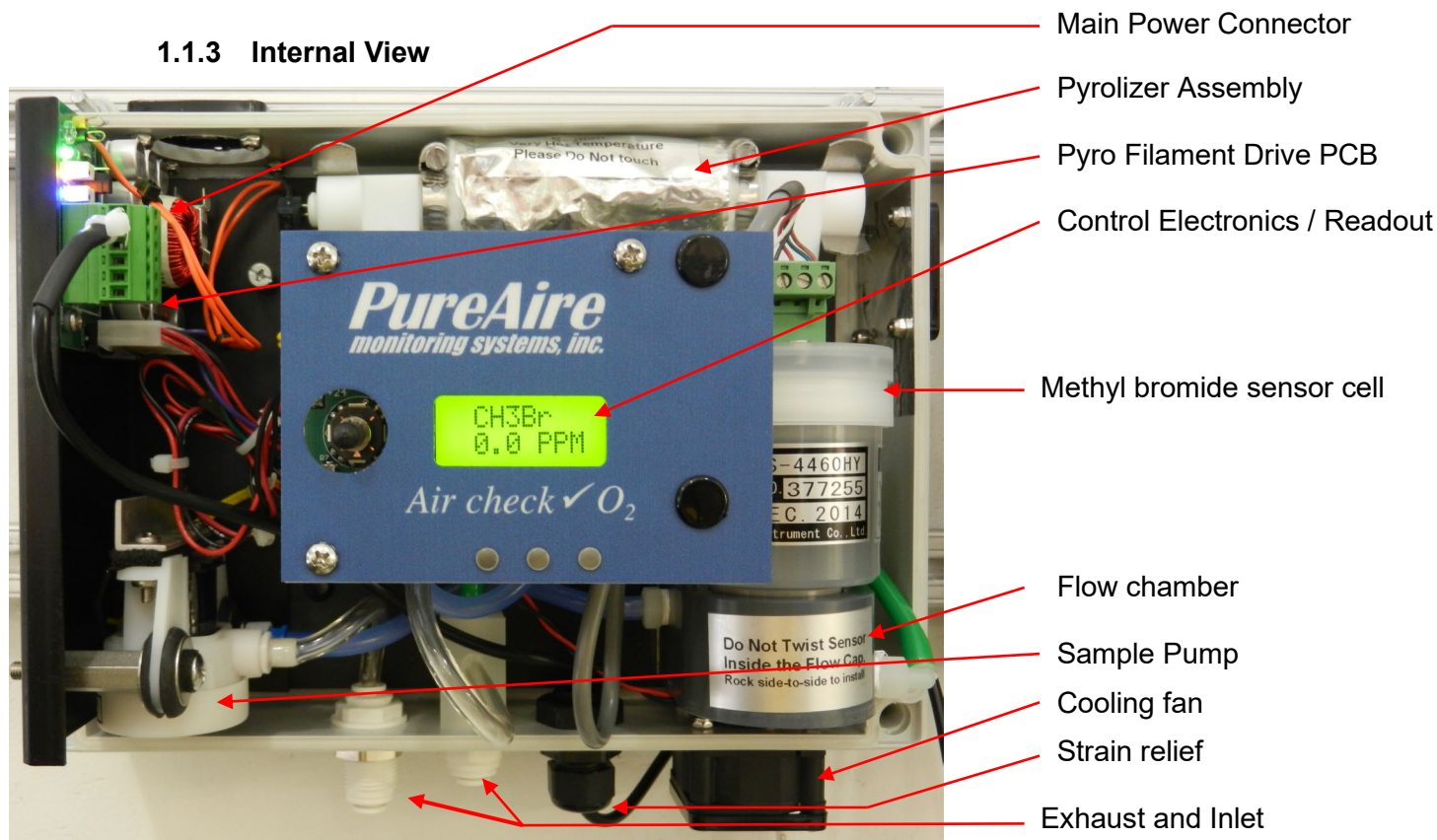

1. **Main Power Connector** — Connector for 24VDC power input. See section 3: Installation for more information.
2. **Pyrolizer Assembly** — Converts Methyl bromide gas into Bromine gas prior to presentation to the gas sensor.

➔ **CAUTION** - *The pyrolizer insulation temperature is above 150 F and can cause burns if touched*

3. **Pyro Filament Drive PCB** — Controls power to the pyrolizer filament and signals the main control electronics if a fault occurs.
4. **Control Electronics and readout** — Controls the sample pump, converts the signal from the sensor cell and sends information to the local digital display and analog /relay terminal block.

➔ **NOTE** – *The flow rate is factory set and is continuously regulated via a built-in flow sensor.*

5. **Flow Chamber** — The converted gas from the pyrolizer is introduced to the gas sensor in this chamber. Sample flow into the chamber is continually monitored. If the sample pump fails, the system fault relay is activated.
6. **Methyl Bromide Sensor Cell** — A renewable electrochemical sensor cell. Typical life is 3 to 6 years under normal operating conditions.
7. **Sample Pump** — This internal sample pump is used to draw the gas sample from the area into the pyrolizer and flow chamber.
8. **Inlet & Exhaust** — These are connections for the incoming gas sample and outgoing exhaust sample

1.2.5 Transmitter Interior

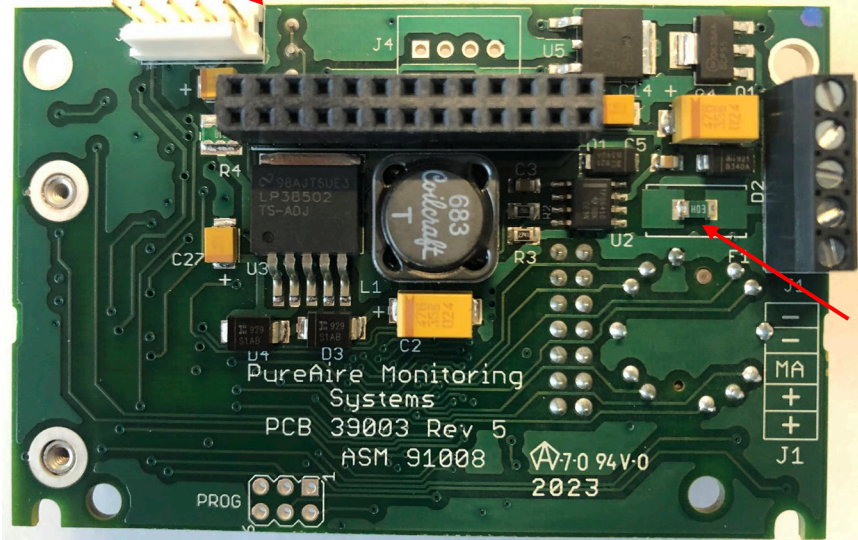

2. Sensor cell connector

1. Power Analog output Terminal Block

Common
Common
mA output
+ 24 VDC
+ 24 VDC

3. PTC Resettable Fuse

1. **Power Analog Terminal Block** — This terminal block is where the 24VDC power and 4-20 mA analog output connection is made.
2. **Sensor Cell Connector** — This connector is where the Oxygen sensor cell is connected. **NOTE: Never connect the oxygen sensor to this connector while the monitor is powered. This will damage the oxygen sensor**
3. **PTC Resettable Fuse** — The PCB is protected with a PTC Fuse that is resettable and Never needs to be replaced. If it trips, you will need to turn power off to the monitor. When power resumes the fuse will reset.

1.2.6 Alarm Relay Board

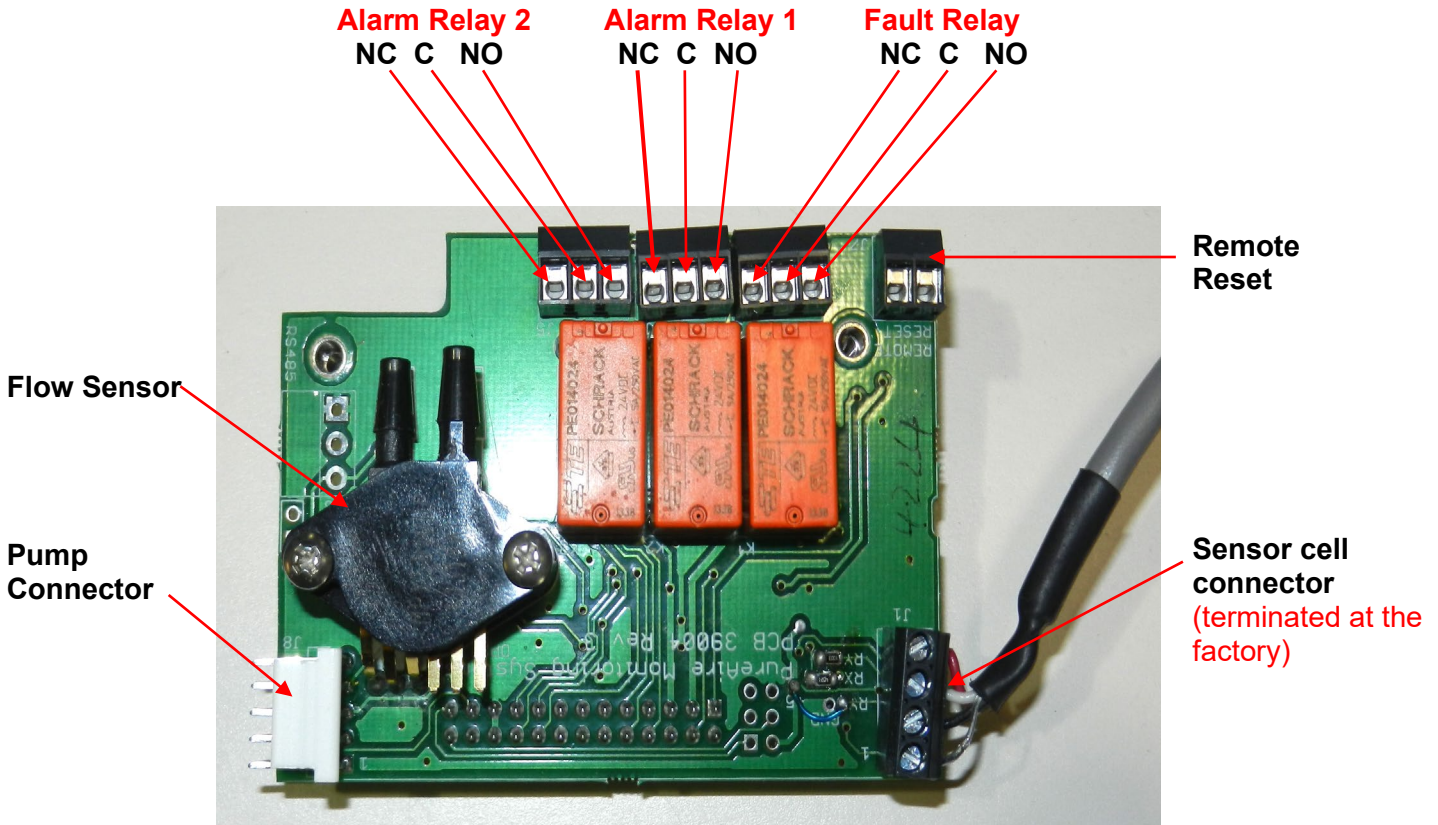

9



Pump and Pyrolizer Drive Assembly

+ 24VDC Pin 6
Common Pin 5

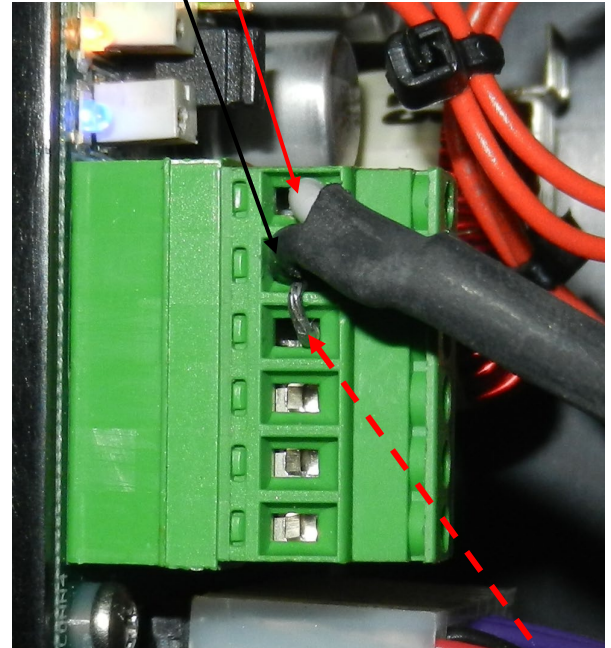

NOTE: DO NOT Remove the shorting pin connected to pins 5 and 4.

Main power connection

(Terminated by PureAire or can be terminated by the customer when using their own power supply)

Status LED's

Green Power LED.

Confirms Power is being supplied to the monitor.

Yellow Status LED.

Confirms the filament drive board is operational.

Blue Fault Status LED.

Flashes to indicate various system faults.

When not in fault the Blue LED remains illuminated continuously

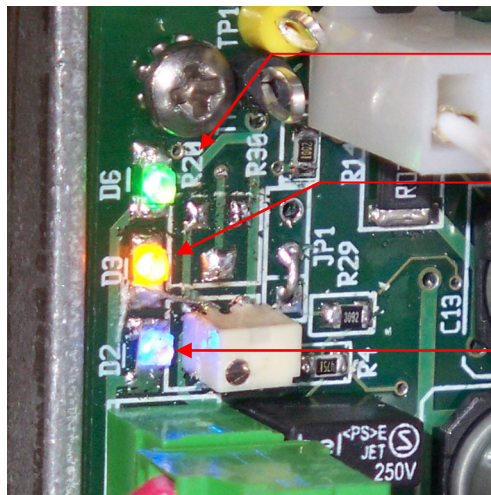

2: Specifications

➔ **NOTE:** *Due to our commitment to continual product improvement, all specifications are subject to change without notice.*

2.1 Performance Specifications

| | |
|-------------------|---|
| Models: | Air Check Methyl Bromide Monitor |
| Sensor Type: | Renewable electrochemical cell. Field rechargeable. |
| Response Time: | Within 60 seconds to T90. |
| Repeatability: | ±10% of full scale. |
| Fault Indicators: | Loss of VDC power (4 mA signal drops to 2, system fault alarm relay de-energizes); Loss of sensor signal (local visual alarms, system fault alarm de-energizes). Loss of sample pump (4 mA signal drops to 2, system fault alarm relay de-energizes) Loss of Pyrolizer filament (4 mA signal drops to 2, system fault alarm relay de-energizes) |
| Operating Temp: | 14° to 86°F (0° to +30°C); consult PureAire for lower or higher operating temperatures. |
| Humidity: | Typically, 20 to 95% RH. |
| Warranty: | The warranty is limited to repairing or replacing the instrument or part thereof for a period of one (1) year after shipment, when in our opinion, the repair or replacement is covered by this warranty. Any defective equipment must be returned prepaid to the PureAire Monitoring Systems, Inc. factory or service. Field service is not included. This warranty does not cover components that are expendable or consumable in normal use and thus have an unpredictable life such as batteries, fuses, sample pumps, filaments, and sensor cell electrolyte & membranes. |

2.2 Gas Detection System

| | |
|-----------------|--|
| Type: | Proprietary renewable electrochemical gas sensor. |
| Sensor Life: | 3 to 6 years under normal conditions. |
| Detectable Gas: | Methyl Bromide Standard Range 0-10ppm * *Consult PureAire for other available gas ranges. |

2.3 Signal Outputs

| | |
|----------------|---|
| Local Display: | Digital display calibrated for Methyl Bromide. The range is stated on the model label and can also be accessed via the joystick on the front panel. |
| Analog Output: | DC 4-20 mA |
| Relay Output: | Dual level user selectable alarm relays and one fault relay Rated, 2amps @ $\leq 30\text{VDC}$; 2amps @ $\leq 250\text{VAC}$ |

2.4 Electrical Requirements

| | |
|--------------|--|
| Power: | 24 VDC external power. ➔ NOTE: Must be a regulated 24VDC Power Supply |
| Consumption: | 2.0 amps. |

2.5 Physical Characteristics

| | |
|-----------------|---|
| Dimensions: | 10" W x 7.0" H x 7.0" D inches; 254 x 178 x 178 mm |
| Weight: | 10 pounds (4.5 kg) |
| Enclosure Type: | NEMA 4X wall mounted enclosure. Not for use in hazardous environments. |

2.6 AirCheck Methyl Bromide Default Factory Settings

The Air Check Methyl Bromide Monitor is shipped with factory defaults for the alarm relay settings. The following are the factory defaults:

| Menu Function | Factory Default | Menu Defined |
|-------------------------------------|--|---|
| Alarm Thresholds | Alarm 1 = 1.0ppm Alarm 2 = 5.0ppm | At what level do you want to alarm? |
| Set Alarm Threshold Polarity | Alarm 1 = Normal Alarm 2 = Normal | Do you want to alarm at a level higher, (normal) or lower, (inverted) than the alarm threshold? |
| Alarm Delay | Alarm = 5 seconds | How long do you want to wait until the alarms activate? |
| Zero Suppression | 0.3ppm | At what level do you want to see the initial gas concentration reading? |
| Set Alarm Hysteresis | Alarm 1 = 0.0 ppm Alarm 2 = 0.0 ppm | For use when using the monitor for control. It is recommended to set both alarm hysteresis at 0.0ppm |
| Relay Latching | Alarm 1 = Non-latching Alarm 2 = Non-latching | Do you want the alarm to automatically reset? (non-latching) or do you want to manually reset the alarm? (latching) |
| Format Relay - LED State ** | Alarm 1 = Normal Alarm 2 = Normal Fault = Normal | Do you want the relays to energize, (normal) or de-energize, (fail safe) when the alarm activates? |

NOTE: The built in relay settings may be changed by the user in the field. Refer to Section 4.5

**** NOTE:** The LED indicators on the front panel are connected directly to the alarm relays.

3: Installation

3.1 Site Requirements

The Air Check Methyl Bromide monitoring system should be mounted in an area free of vibration and electrical noise or interference. If possible, avoid areas with continuous high temperatures or relative humidity.

The unit should be installed in a location where gas leaks are likely to occur or where released gases may accumulate. Airflow within the monitored area, the characteristics of the target gas (lighter or heavier than air), and the position of workstations and personnel should all be considered in determining the most suitable installation location.

Allow sufficient space around the instrument to permit access for maintenance and calibration.

- ➔ **NOTE:** *The Air Check Methyl Bromide Monitor is NOT designed for installation in hazardous areas.*

3.2 Mounting

The Air Check is designed primarily for wall mounting and should be installed no closer than 36 inches (915 mm) above floor level. If mounted outdoors, keep direct sunlight off of the enclosure.

3.3 Sensor Installation

- ➔ **IMPORTANT:** *Be careful not to turn the sensor or touch the membrane on the bottom of the sensor during installation.*
- ➔ **CAUTION:** *The target gas is factory programmed and cannot be adjusted in the field. Failure to install the correct sensor in the instrument will adversely affect detection reliability and/or measurement accuracy.*

1. Remove the front cover by turning the cover counter clockwise.
2. Remove the sensor shorting plug.
3. Plug the Methyl Bromide sensor into the flow chamber inside the instrument housing.

NOTE: *Do not twist the gas sensor inside the flow chamber. This may loosen the sensor cell box nut on H type renewable sensor cells.*

- ➔ **IMPORTANT:** Remove the shorting plug from the sensor cell connector before connecting the sensor cell to the transmitter.



Insert the sensor cell into the flow chamber by pushing the sensor cell down until it seats inside the O-ring.

Never twist the sensor cell inside the flow chamber.

3.4 Wiring

3.4.1 24 VDC Power

Connect the 24 VDC power cable to the terminal block located on the inside of the instrument. The terminal connections are as follows: (Pin 6) +24V, (Pin 5) Common, and (Pin 4) shield. A three-wire shielded cable (3-conductor, 18 AWG stranded shielded) General Cable #E2203S.30.86 or equivalent should be used for the connection. The total length of the cable between the gas detector and controller must not exceed 0.62 miles (1 km).

➔ **CAUTION:** The Air Check Methyl Bromide Monitor must only be powered using a regulated 24VDC Power Supply. Failure to use a regulated 24VDC power supply will void the warranty.

The 24 VDC power in connections are made on the 6 pin terminal connection located on the Power Supply PCB. These connections are made as follows:

| Pin # | Connection |
|-------|------------|
| 6 | DC + 24V |
| 5 | Common |
| 4 | Shield |

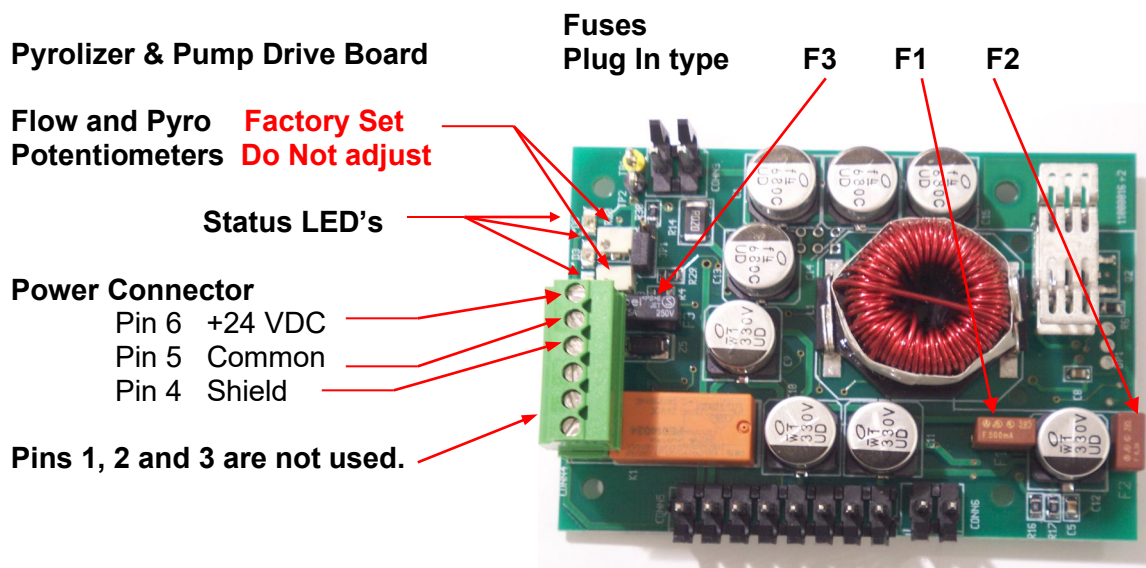

3.4.2 Alarm Relays

The Air Check monitor incorporates two gas concentration alarm relays and one system fault relay. These relays may be wired for normally open (N.O.) or normally closed (N.C.) operation and are rated as follows: **Rated, 2amps @ 30VDC; 2amps @ 250VAC. See page 9.**

3.5 Initial Startup

Once installation of the gas detector has been completed, it is ready for startup. The following procedures should be performed before putting the instrument into operation:

1. Check the integrity of all wiring. Confirm the power polarity.
2. Run any sample tubing from the monitor to the risk site.

NOTE: PureAire recommends the use of polypropylene sample tubing with the dimensions of 1/4" OD by 3/16" ID. The total length of tubing should not exceed 100 feet.

3. Apply 24 VDC power to the Power Supply PCB board. The sample pump and pyrolizer heater will operate.

NOTE: The Air Check requires a regulated 24VDC power supply

➔ **CAUTION - The pyrolizer insulation temperature is above 150 F and can cause burns if touched.**

The monitor is now ready to power up. On power up, the monitor will immediately start a 4-minute countdown and the green and yellow LEDs will be illuminated next to the power connector. It will then display **CH₃Br** on the top line and countdown from **244 to 0** and display **WARM** on the bottom line. Also, the **Yellow Fault LED** will be illuminated on the front panel.

After the 4-minute countdown, the blue LED will illuminate and **"Pyrolizer Heater Fault"** will scroll on the top line, **F02 00** will display on the bottom line and the **Yellow Fault LED** will still remain illuminated.

Approximately 30 seconds later, the **"Pyrolizer Heater Fault"** and **F02 fault message** will clear and **CH₃Br** will display on the top line, a **ppm gas** concentration will display on the bottom line of the digital display and the **Yellow Fault LED** will turn off.

➔ **NOTE: After power up, please let the system equilibrate a few hours before making any zero and span adjustments. The Methyl Bromide sensor may read a high ppm gas concentration on startup. The sensor's zero will stabilize during this warm period.**

➔ **NOTE: The monitor is designed for continuous 24-7 hour operation. Do not power down the monitor unless you intend to store the monitor. Cycling the monitor on and off will diminish the performance of the methyl bromide readings.**

After the 2 hour warm up, if the monitor is reading a positive PPM, and you are sure that it is not being exposed to methyl bromide then re adjust the zero. **Refer to section 5.4.3.**

3.5.1 Pump Adjustment

The Air Check Methyl Bromide Monitor has a built in digitally controlled flow controlled sample pump. The pump flow is set at the factory and should not require adjustment. It has a range to accommodate tubing lengths up to 100 feet. Flow rate is between 0.5 and 0.9 SCFH. If flow adjustment is necessary, please contact PureAire.

4: Air Check Monitor Programming

The Air Check Methyl Bromide Monitor is supplied with user selectable settings to adjust the alarm settings, 4 and 20mA output and minor sensor adjustments. The settings are arranged in menus that are accessed by moving the joystick. To access the menus a factory set password is used.

NOTE: The Air Check Methyl Bromide Monitor will continuously monitor Methyl bromide while accessing the menus. The alarm, fault relays and mA output are all active and on line while making any changes to the menus.

4.1 Control Panel Overview

All instrument configuration and operational programming is performed from the front panel of the Air Check Monitor using the joystick.



4.2 Joystick Operation

The Air Check Methyl Bromide monitor uses a 4-position joystick with a center pushbutton for selecting menus and changing values. The joystick is programmed to standard protocol as follows:

NOTE: *The joystick has a built-in delay to prevent accidental tampering of the menus. Deliberate entries are required.*

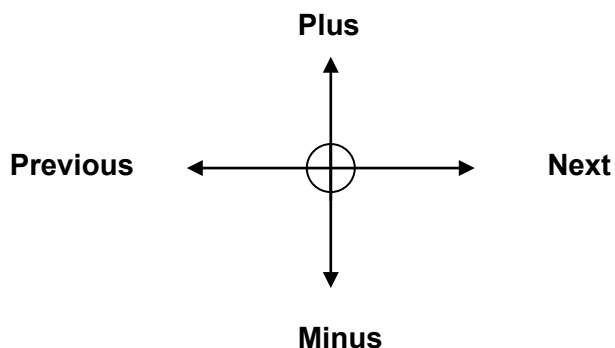

Plus – Pushing the joystick in this direction increases the value

Minus – Pushing the joystick in this direction decreases the value

Next – Pushing the joystick in this direction moves you to the next level of the menu hierarchy.

Previous – Pushing the joystick in this direction takes you out to the last level of menu hierarchy.

Enter – Pushing the joystick directly in the center enters the information into the microprocessor

NOTE: The joystick has four other positions that are only used to only access factory menus. A separate factory password is required obtain entry.

4.3 Program Flowchart

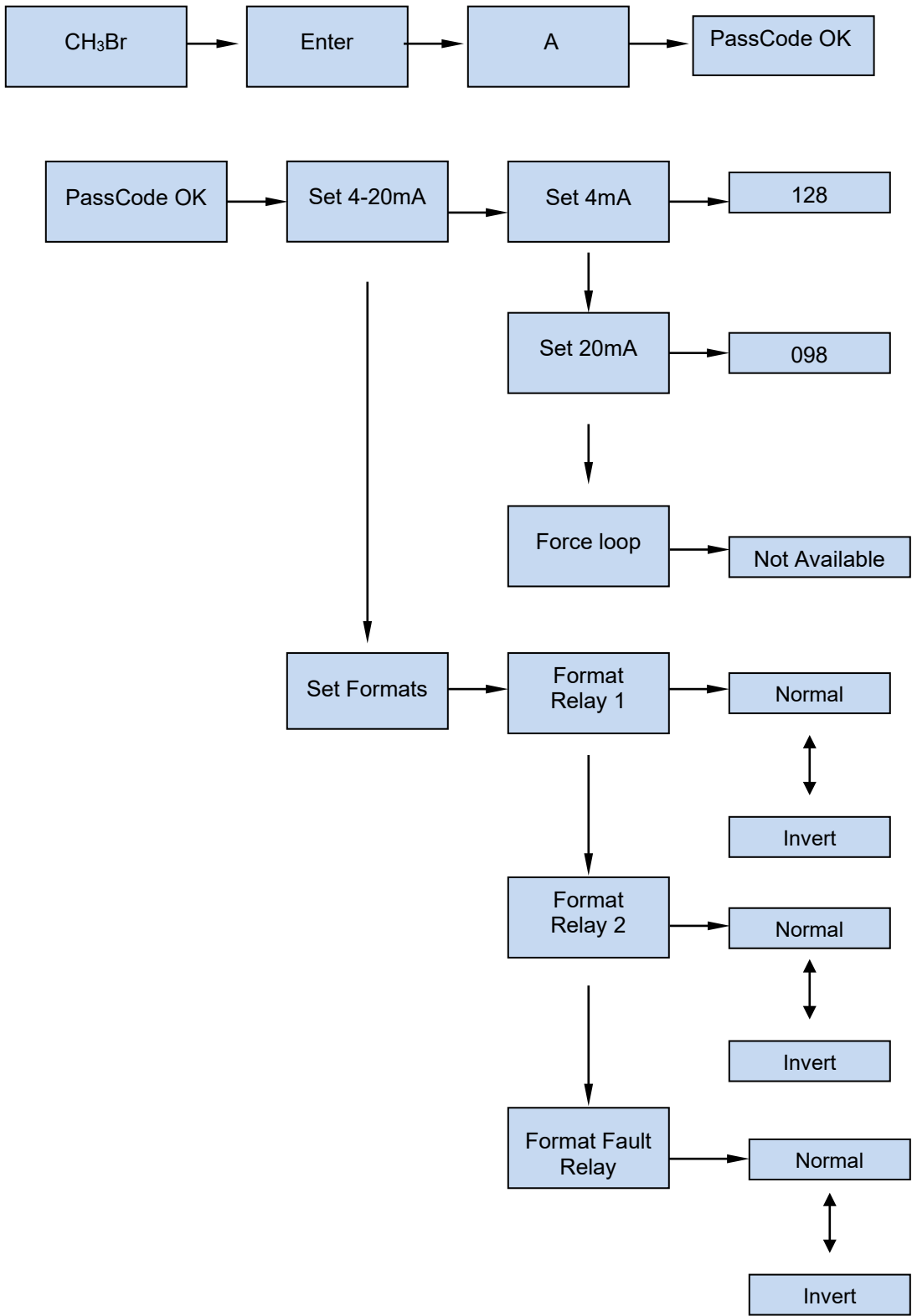

NOTE: All numerical values shown are only examples and are not Factory Defaults

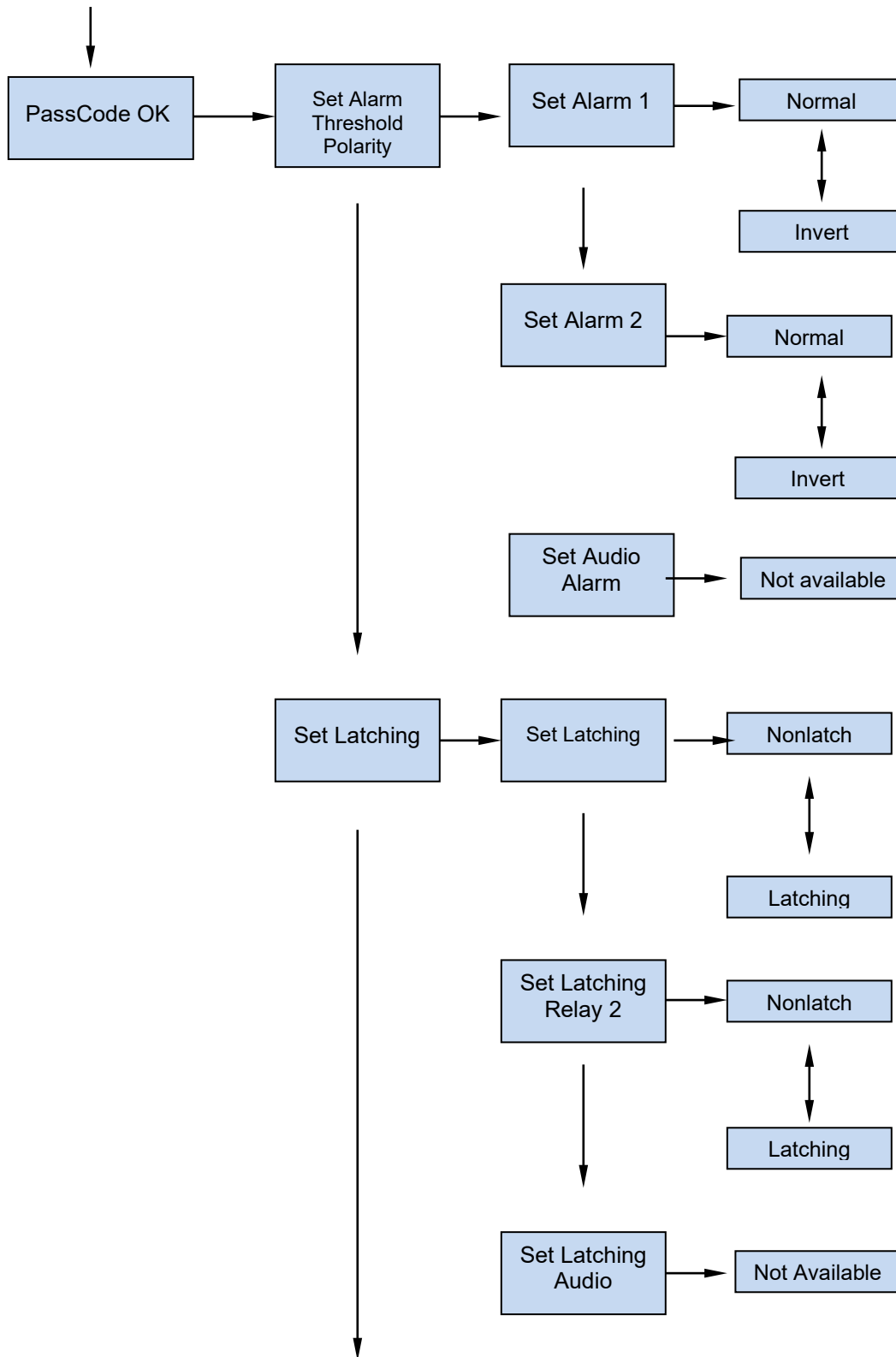

NOTE: All numerical values shown are only examples and are not Factory Defaults

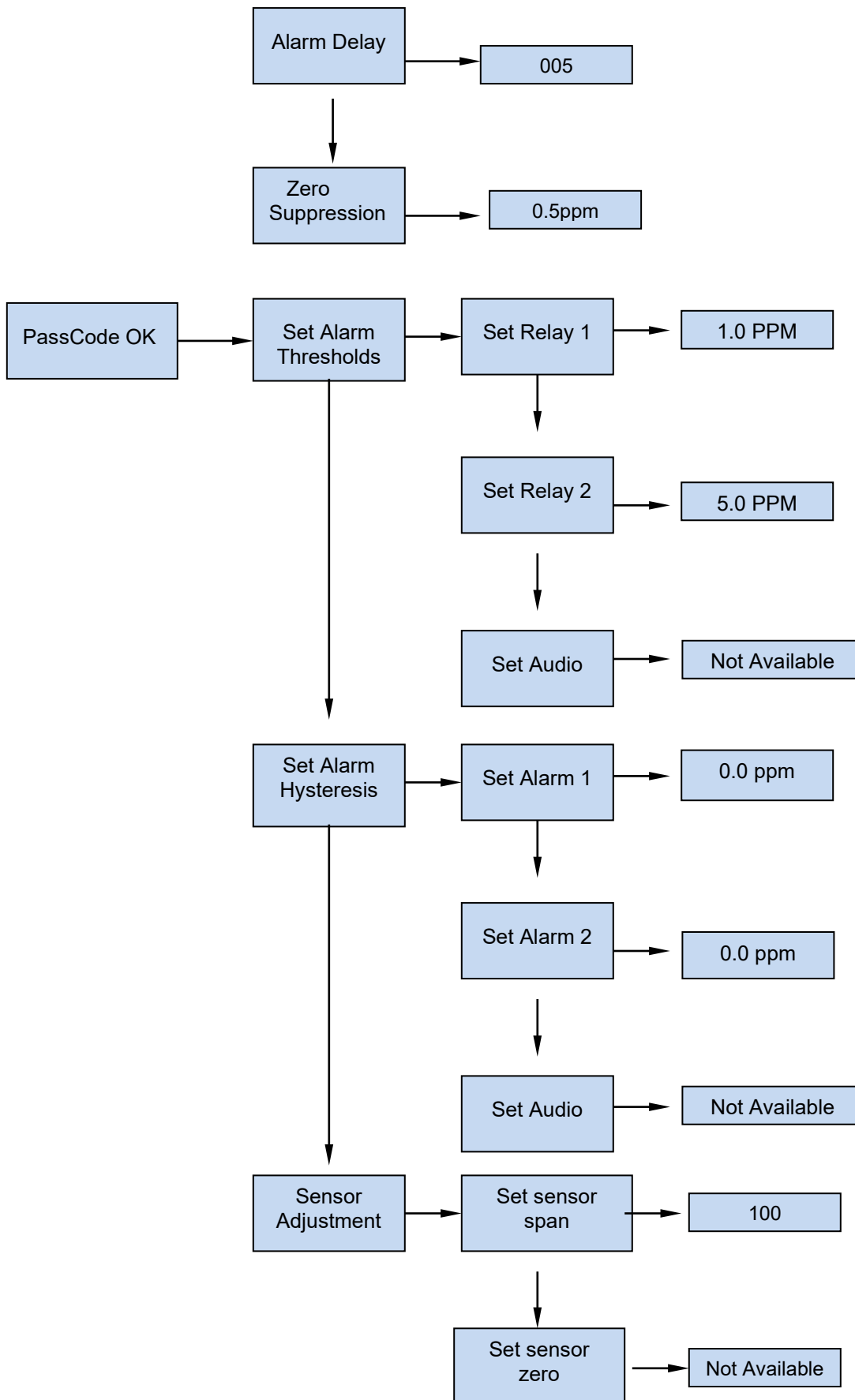

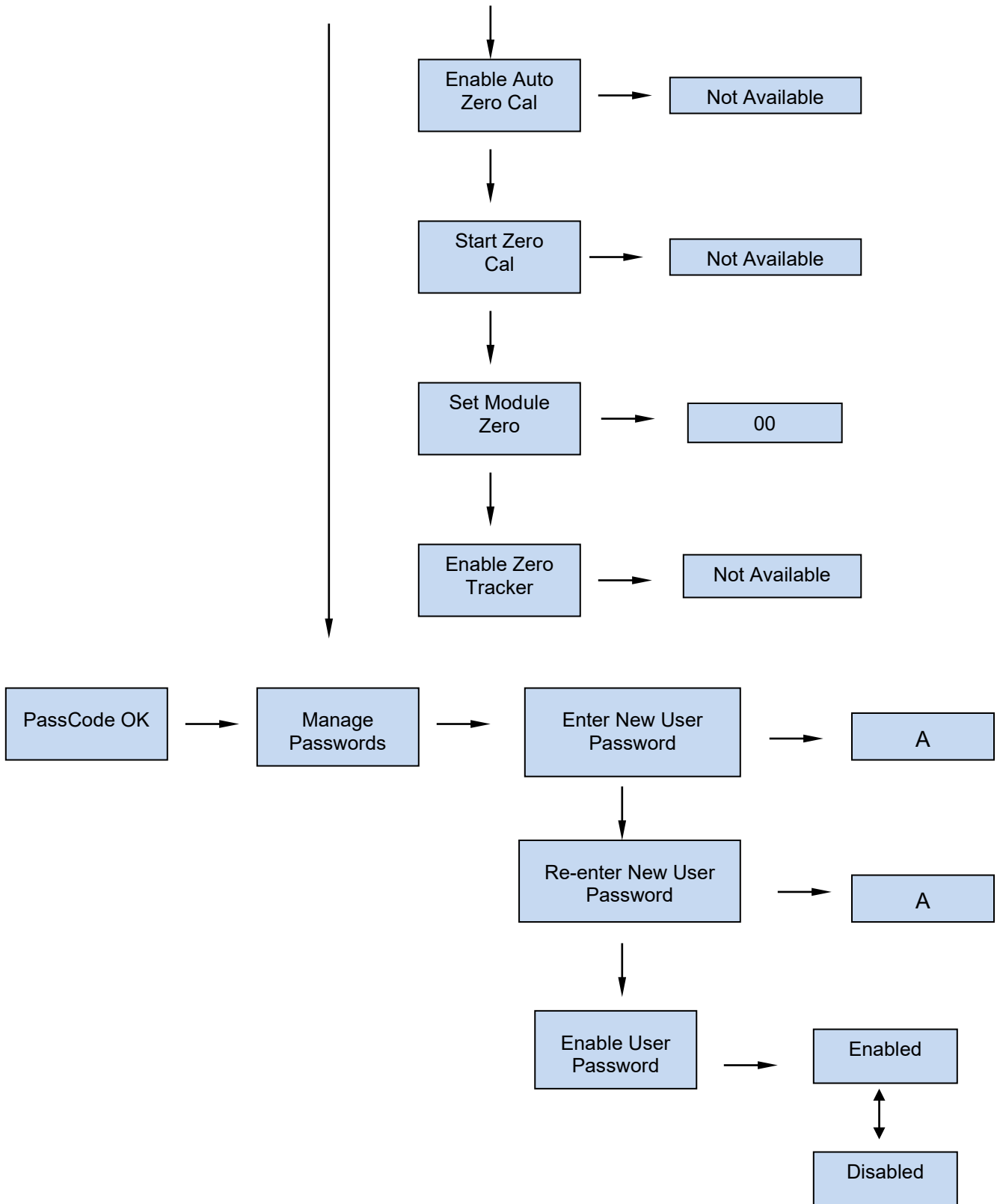

4.4 Entering the Password

The Air Check Methyl Bromide monitor is supplied with a factory set password to prevent unauthorized access to the menus. **The Password is 557.** The following explains how to enter the password.

1. Push the joystick once to the right. **Enter Password** will scroll on the first line of the digital display. The second line will still display the current oxygen level.

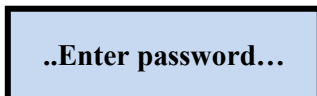

..Enter password...

2. Push the joystick again once more to the right to enter the input screen. **The letter A will appear and flash.**

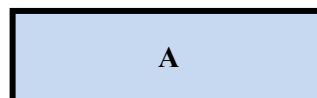

A

NOTE: *The display has characters that start with A through Z and 0 through 9. Pushing the joystick up or down will permit you to scroll through the alphanumeric characters.*

3. Push the joystick up or down to enter the first digit. The display is an alphanumeric display and toggles from A through Z followed by 0 to 9. The character to be entered will flash.



5

4. Push the joystick again to the right to select the second entry. Push the joystick up or down to select the second digit. The character being entered will flash and the first character entered will remain lit.

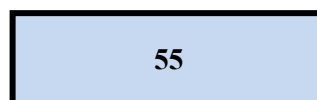

55

5. Push the joystick again to the right to select the third entry. Push the joystick up or down to select the third and final digit. The character being entered will flash and the first and second characters entered will remain lit. You are now ready to enter the 3-digit password.



557

6. Push the joystick in the center to enter the password. If you entered it correctly the display will scroll **Password OK**.



...Password OK.....

NOTE: If an incorrect password has been entered, the display will indicate Password Failed. Push the joystick to the left to access the monitoring mode. From this mode you can reenter the password again.

4.5 Changing the User Password

The Air Check Methyl Bromide monitor is supplied with a factory set password to prevent unauthorized access to the menus. The user can change this password and the following explains how to change the password.

1. Push the joystick down to access the **Manage Passwords Menu**. **Manage Passwords** will scroll on the first line of the digital display. The second line will still display the current oxygen level.



..Manage Passwords...

2. Push the joystick to the right to enter the input screen. **Enter New User Password** will scroll on the first line of the digital display



...Enter New User Password...

0.0 PPM

3. Push the joystick to the right to enter the input screen. **The letter A will appear and flash.**



A

NOTE: *The display has characters that start with A through Z and 0 through 9. Pushing the joystick up or down will permit you to scroll through the alphanumeric characters.*

4. Push the joystick up or down to enter the first digit. The display is an alphanumeric display and toggles from A through Z followed by 0 to 9. The character to be entered will flash.



2

5. Push the joystick again to the right to select the second entry. Push the joystick up or down to select the second digit. The character being entered will flash and the first character entered will remain lit.



25

6. Push the joystick again to the right to select the third entry. Push the joystick up or down to select the third and final digit. The character being entered will flash and the first and second characters entered will remain lit. You are now ready to enter the 3-digit password.

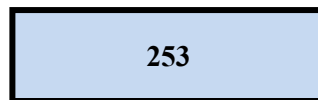

253

7. Push the joystick in the center to enter the password. This will display the next command, **Re-Enter New Password**

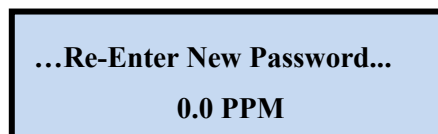

...Re-Enter New Password...
0.0 PPM

8. Push the joystick to the right to enter the input screen. **The letter A will appear and flash.**

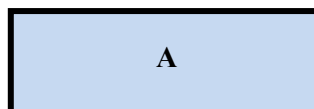

A

9. Push the joystick up or down to enter the first digit. The display is an alphanumeric display and toggles from A through Z followed by 0 to 9. The character to be entered will flash.

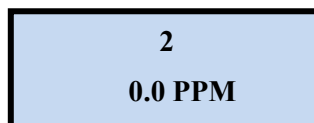

2
0.0 PPM

10. Push the joystick again to the right to select the second entry. Push the joystick up or down to select the second digit. The character being entered will flash and the first character entered will remain lit.



25

11. Push the joystick again to the right to select the third entry. Push the joystick up or down to select the third and final digit. The character being entered will flash and the first and second characters entered will remain lit. You are now ready to enter the 3-digit password.



253

12. Push the joystick in the center to enter the password. If you entered it correctly the display will scroll “New Password Entry OK”.



...New Password Entry OK...

NOTE: If on the second entry the password entered was different from the first, the display will take you back to the “Re-enter Password Screen”. You’ll need to repeat steps 2 through 11. If you do not enter the password correctly, the monitor remembers the last password that was properly input.

If you misplace or lose your password, contact PureAire with the monitors DTM# for instructions on recovering your password. The DTM# is displayed by moving the joystick to the left.

4.5.1 Enable User Password

This menu permits the user to activate or disable the password function on the Methyl Bromide monitor. Push the joystick down. “Enable User Password” will scroll on the first line of the digital display



...Enable User Password...

Push the joystick right to display the status. If enabled it will display ”Enabled”



Enabled

Push the joystick up or down to change the status. Once enabled or disabled is selected, Push the joystick in the center to enter the new status. If correctly entered the display will scroll “Enable User Password”



...Enable User Password...

0.0 PPM

4.6 Entering the Menus

The Air Check Methyl Bromide monitor is supplied with main menus with sub menus to adjust mA outputs, alarm relay settings, sensor adjustments and zero suppression.

4.6.1 Set 4-20mA loop



.Set 4-20mA loop..

This main menu will permit the adjusting of the 4mA and 20mA output from the Air Check Methyl Bromide Monitor. It also provides a function that will send an actual output between 4mA and 20 mA to test any remote control and alarm system attached to the methyl bromide monitor.

NOTE: *To read the mA output, Air Check monitor must either be connected to a remote PLC controller or SCADA system. You can also connect the Air Check monitor to a volt meter to read the mA output. Please consult PureAire for more information.*

From this main menu, pushing the joystick to the right will select the sub menu and the digital display will scroll the following:



..Set 4mA zero...

This is the menu at which to adjust the 4mA output being sent from the Air Check Monitor.

To change this value, push the joystick right to display the 4 mA setting. The display will indicate a value between 0 and 255 counts. Pushing the joystick up increases the value and pushing the joystick down decreases the value. The 4mA output being sent from the Air Check Methyl Bromide monitor will change as the number on the digital display changes. Press **ENTER** to accept the value.



255

Push the joystick to the left brings you back to the pervious Main menu. The digital display will scroll the following:



...Set 4mA zero.....

Push the joystick down to access the next sub menu; **Set 20mA Span will scroll.**



...Set 20mA Span...

This is the menu at which to adjust the 20mA output being sent from the Air Check Monitor.

To change this value, push the joystick right to display the 20mA span setting. The display will indicate a value between 0 and 255 counts. Pushing the joystick up increases the value and pushing the joystick down decreases the value. The 20mA output being sent from the Air Check monitor will change as the number on the digital display changes. Press **ENTER** to accept the value.



255

Push the joystick to the left brings you back to the pervious Main menu. The digital display will scroll the following:



...Set 20mA span.....

Push the joystick down to access the next sub menu; **Force loop will scroll.**



...Force Loop....

NOTE: *This menu item is not available on the Methyl Bromide monitor.*

Push the joystick to the left brings you back to the pervious menu. The digital display Will scroll the following:



...Set 4-20mA loop.....

4.6.2 Set Formats

This is the menu at which to adjust the relay states for the two gas alarm relays and the individual instrument fault relay.

Push the joystick down to access the next main menu, **Set Formats.** The display will scroll the following:

**...Set Formats...
0.0ppm**

This menu will permit the setting of the two alarm relays and the fault relay settings from normally de-energized state, **Normal**, to normally energized state, **Inverted**.

From this main menu, pushing the joystick to the right will select the sub menu and the digital display will scroll the following:

..Format Relay 1...

This is the menu at which to adjust the first level alarm relay state on the Air Check AN Monitor.

To change this value, push the joystick right to display the relay state. The display will indicate **NORMAL**. Pushing the joystick down will change the relay state from **NORMAL** to **INVERT**. Press **ENTER** to accept the value.

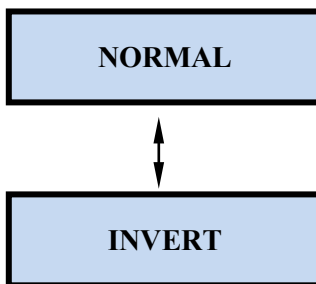

After entering the relay state, the display will default back to the Set Formats menu. The display will scroll the following:

..Set Formats...

From this main menu, pushing the joystick to the right will select the sub menu and the digital display will scroll the following:

..Format Relay 1...

Push the joystick down to access the next main menu, **Set Formats**. The display will scroll the following:

**... Format Relay 2..
0.0ppm**

This is the menu at which to adjust the second level alarm relay state on the Air Check Monitor.

To change this value, push the joystick right to display the relay state. The display will indicate **NORMAL**. Pushing the joystick down will change the relay state from **NORMAL** to **INVERT**. Press **ENTER** to accept the value.

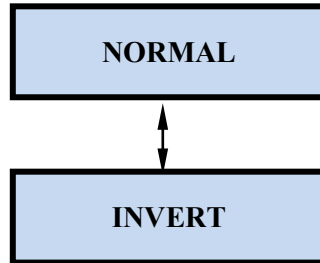

After entering the relay state, the display will default back to the Set Formats menu. The display will scroll the following:



From this main menu, pushing the joystick to the right will select the sub menu and the digital display will scroll the following:



Push the joystick twice to select the fault relay to be adjusted. The display will scroll; **Format Fault Relay**.

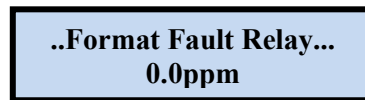

This is the menu at which to adjust the fault alarm relay state on the Air Check Monitor.

To change this value, push the joystick right to display the relay state. The display will indicate **NORMAL**. Pushing the joystick down will change the relay state from **NORMAL** to **INVERT**. Press **ENTER** to accept the value.

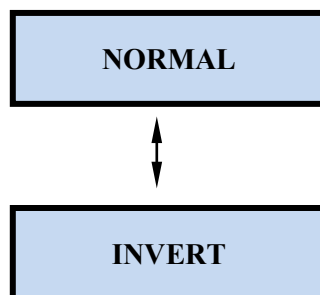

After entering the relay state, the display will default back to the Set Formats menu. The display will scroll the following:



4.6.3 Set Alarm Threshold Polarity

Alarm Threshold Polarity determines if an alarm concentration is set above or below a threshold value. For example, if an alarm of 2.0ppm is selected, the Alarm Threshold Polarity must be set to **Normal** for the monitors alarm to activate when the reading goes above 2.0ppm. Selecting an **Invert** setting for the Alarm Threshold Polarity means that the system will alarm when the gas concentration goes below an alarm set point. This menu will permit the selection of the alarm polarity. To access this menu from the “Set Formats” menu, push the joystick down to display the **Set Alarm Threshold Polarity** adjustment menu. This will scroll on the digital display.

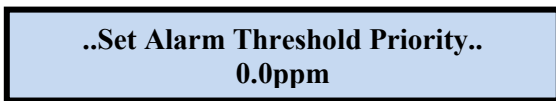

Push the joystick right to access the first sub menu; **Set Alarm 1 Polarity** will scroll on the display. This is the menu at which to adjust the first level alarm polarity state on the Air Check Methyl Bromide Monitor.

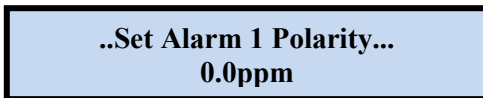

To change this value, push the joystick right to display the relay state. The display will indicate **INVERT**. Pushing the joystick down will change the relay state from **INVERT** to **NORMAL**. Press **ENTER** to accept the value.

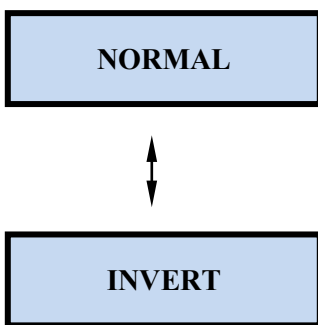

After entering the relay state, the display will default back to the Set Alarm 1 Polarity menu. The display will scroll the following:

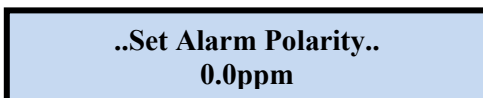

Push the joystick down to access the next sub menu; **Set Alarm 2 Polarity** will scroll on the display. This is the menu at which to adjust the second level alarm polarity state on the Air Check Methyl Bromide Monitor.

**..Set Alarm 2 Polarity ..
0.0ppm**

To change this value, push the joystick right to display the relay state. The display will indicate **NORMAL**. Pushing the joystick down will change the relay state from **NORMAL** to **INVERT**. Press **ENTER** to accept the value.

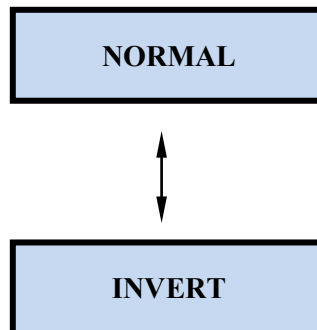

After entering the relay state, the display will default back to the Set Relay 2 Alarm Threshold menu. The display will scroll the following:

**..Set Alarm 2 Polarity..
0.0ppm**

Push the joystick down to access the next sub menu; **Set Audio Alarm Polarity** will scroll on the display. This is the menu at which to adjust the second level alarm polarity state on the Air Check AN Monitor.

**..Set Audio Alarm Polarity...
0.0ppm**

NOTE: *The audio alarm option module is not available for Methyl Bromide*

4.6.4 Set Latching

This is the menu at which to adjust the relay alarm state for the two gas alarm relays and the individual instrument fault relay. The selection permits setting the relays to a latching or non-latching state. In a latching state, the relay will remain activated until the user manually selects the Enter Key. In a non-latching state, the alarm relay will automatically reset once the gas concentration has returned to 0.0ppm Methyl Bromide.

**.Set Latching...
0.0ppm**

This menu will permit the setting of the two alarm relays and the fault relay settings from a latching to a non latching state when they are activated.

From this main menu, pushing the joystick to the right will select the sub menu and the digital display will scroll the following:

**..Set Latching Relay 1...
0.0ppm**

This is the menu at which to adjust the first level alarm relay state on the Air Check Monitor.

To change this value, push the joystick right to display the relay state. The display will indicate **LATCH**. Pushing the joystick down will change the relay state from **LATCHING** to **NON-LATCHING**. Press **ENTER** to accept the value.

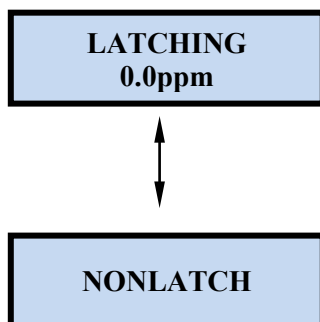

After entering the relay state, the display will default back to the **Set Latching** menu. The display will scroll the following:

**..Set Latching....
0.0ppm**

From this main menu, pushing the joystick to the right will select the sub menu and the digital display will scroll the following:

**..Set Latching Relay 1...
0.0ppm**

Push the joystick down to select the next relay to be adjusted. The display will scroll the following, **Set Latching Relay 2.**

**..Set Latching Relay 2...
0.0ppm**

This is the menu at which to adjust the second level alarm relay state on the Air Check Monitor.

To change this value, push the joystick right to display the relay state. The display will indicate **LATCHING**. Pushing the joystick down will change the relay state from **LATCHING** to **NONLATCH**. Press **ENTER** to accept the value.

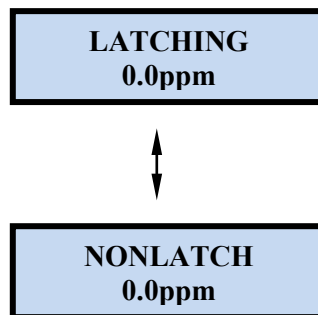

After entering the relay state, the display will default back to the **Set Latching** menu. The display will scroll the following:

**..Set Latching....
0.0ppm**

From this main menu, pushing the joystick to the right will select the sub menu and the digital display will scroll the following:

**..Set Latching Relay 1...
0.0ppm**

Push the joystick twice to select the Audio Alarm relay to be adjusted. The display will scroll; **Set Latching Audio Alarm.**

NOTE: The audio alarm option module is not available for Methyl Bromide.

4.6.5 Set Alarm Delay

Push the joystick down to access the next main menu, **Alarm Delay**. The display will scroll the following:

...Alarm Delay...
0.0ppm

This is the amount of time an alarm level concentration of oxygen must be present before the instrument's gas concentration alarm(s) will be activated. This menu will permit setting a user selected time delay for activating alarm relays 1 and 2. You can select from 0 seconds up to 255 seconds after an alarm level has been exceeded before the alarm relays to activate.

To change this value, push the joystick right to display the time screen. The display will indicate a value between 0 and 255 seconds. Pushing the joystick up increases the value and pushing the joystick down decreases the value. Press **ENTER** to accept the value.

005
0.0ppm

After entering the alarm delay, the display will default back to the Alarm Delay menu and the display will scroll the following:

...Alarm Delay...
0.0ppm

NOTE: *The alarm delay is only available for alarms 1 and 2. There is no delay for the fault relay. Any system fault will immediately activate the Fault Relay.*

4.6.6 Set Zero Suppression

This setting is used to decrease the sensitivity of selected gas sensors. It essentially programs the instrument to ignore gas measurements that are below the programmed ppm level.

EXAMPLE: *If the measurement range of the instrument is 0 to 30 ppm, gas measurements below 0.5 ppm will be displayed and output as 0 (zero) when the suppress level is set at 0.5ppm.*

...Zero Suppression...
0.0 PPM

To change this value, push the joystick right to display the Zero Suppression screen. The display will indicate a value between 0 and 100%. Pushing the joystick up increases the value and pushing the joystick down decreases the value. Press **ENTER** to accept the value.

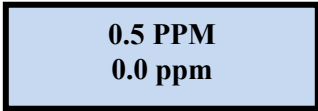

0.5 PPM
0.0 ppm

After entering the zero suppression value, the display will default back to the **Zero Suppression** menu and the display will scroll the following:

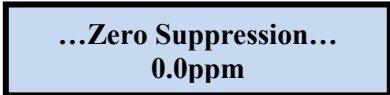

...Zero Suppression...
0.0ppm

4.6.7 Set Alarm Thresholds

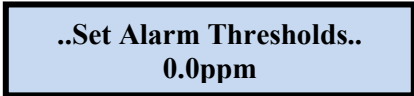

..Set Alarm Thresholds..
0.0ppm

This main menu will permit adjusting the Methyl Bromide concentration ppm level that will activate alarm levels 1 and 2.

From this main menu, pushing the joystick to the right will select the first sub menu and the digital display will scroll the following: **Set Relay 1 Alarm Threshold.**



..Set Relay 1 Alarm Threshold...
0.0ppm

This is the gas concentration at which the instrument's first level alarm will be activated. To change the displayed value, push the joystick to the right to display the first level alarm setting. The display will indicate a value between 0.0ppm and full scale.

Pushing the joystick up increases the value and pushing the joystick down decreases the value. Press **ENTER** to accept the value.

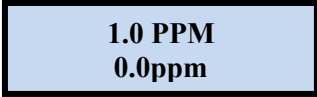

1.0 PPM
0.0ppm

After entering the relay state, the display will default back to the **Set Relay 1 Alarm Threshold** Menu. The display will scroll the following:



..Set Relay 1 Alarm Threshold...
0.0ppm

Push the joystick down to access the next sub menu; **Set Relay 2 Alarm Threshold,**

will scroll on the digital display.

**..Set Relay 2 Alarm Threshold...
0.0ppm**

This is the gas concentration at which the instrument's second level alarm will be activated. To change the displayed value, push the joystick to the right to display the second level alarm setting. The display will indicate a value between 00.0% and full scale.

Pushing the joystick up increases the value and pushing the joystick down decreases the value. Press **ENTER** to accept the value.

**5.0 PPM
0.0 PPM**

After entering the relay state, the display will default back to the **Set Relay 2 Alarm Threshold** Menu. The display will scroll the following:

**..Set Relay 2 Alarm Threshold...
0.0ppm**

Push the joystick down to access the next sub menu; **Set Audio Alarm Threshold**, will scroll on the digital display.

NOTE: *The audio alarm option module is not available for Methyl Bromide.*

4.6.8 Set Alarm Hysteresis

This function was designed for PureAire's Oxygen deficiency monitor when used as a control system.

NOTE: The Hysteresis function is permits a user to set the dead band for both Alarms 1 and 2 and is not applicable to the Methyl Bromide toxic gas monitor. The Hysteresis setting is factory set at 0.0 ppm **It is recommended to set both alarm hysteresis at 0.0ppm. Changing it will affect when the alarm relay deactivates after tripping.**

4.6.9 Sensor Adjustment

**..Sensor Adjustment...
0.0ppm**

NOTE: Refer to Section 5.5 Sensor Calibration for complete instructions on the use of this menu.

5: Maintenance & Calibration

Only qualified personnel should perform maintenance and calibration.

5.1 Routine Maintenance Schedule

Continuous gas detection systems depended upon to measure and detect hazardous gas leaks in the workplace requires periodic maintenance to ensure proper operation. The frequency with which this routine maintenance is required depends on the environment, since temperature, humidity, gas concentrations, and dust all affect system operation.

The following table is intended to serve as a general guideline for routine maintenance. The conditions in your particular application, as well as your organization's maintenance policies, will ultimately determine the best routine maintenance schedule for your equipment.

5.1.1 Routine Visual Checks

| Item | Status With No Gas Present |
|--------------------------------|--------------------------------|
| Local Display | Display should read "0.0" |
| 4-20 mA Output | Output should be 4 mA |
| Gas Concentration Alarm Relays | De-energized (factory default) |
| System Fault Relay | De-energized (factory default) |

5.1.2 Recommended Routine Maintenance Schedule

| | |
|---|---|
| Routine Visual Checks (flow, fault LED) | Quarterly |
| Flow rate and power status | Continually supervised. Flow is constantly monitored and adjusted by the internal CPU Automatic hourly system integrity verification |
| Electrolyte Replacement (p/n 84004) | Every 6 months |
| Membrane Replacement (p/n 82020) | Every 6 months |
| O-rings and silicon sheets (p/n 86001) (p/n 86002) | Replace when damaged |
| Sensor Calibration | Every 3 months under continuous CH ₃ Br exposure Every 6 months under normal use |
| Pyrolizer Filament (p/n 46003) | Replace when damaged. |
| Sample Inlet Filter (p/n 23102) | Replaced when clogged |

5.2 Loss of Power Indication

In the event the Air Check Methyl Bromide Monitor loses VDC power, the local display will go blank and the 4-20 mA analog output signal drops to 0 and the system status alarm relay de-energizes.

- ➔ **IMPORTANT:** *If the instrument was in Measure mode when power was lost, it will automatically return to Measure mode when power is restored.*

5.3 Sensor Cell Removal and Installation

5.3.1 Sensor Removal

DO NOT Power Down the monitor. This procedure should be performed with the monitor powered ON to maintain the Pyrolizer temperature.

1. Remove the sensor by gently rocking the sensor side-to-side and simultaneously pulling it up from the flow chamber.
2. Place a flat business card over the opening of the flow chamber to seal the opening. This will prevent a flow fault.
3. Unplug the sensor cable from the sensor cell by pulling straight up.

- ➔ **CAUTION:** Do not twist the sensor; this will loosen the box nut and cause the cell to leak electrolyte
- ➔ **CAUTION:** Avoid spilling electrolyte out of the small opening on the side of the sensor.

To Remove

Gently rock the sensor side to side side-to-side and simultaneously pulling it up from the flow chamber.



Sensor Cell Cable and connector

Methyl Bromide Renewable Sensor Cell

To Install

Install the sensor cell into the flow cap by gently rocking the cell and pushing straight down until it seats.

Note: A small gap between the cell and flow cap is normal.

Flow Chamber

Methyl Bromide Sensor and Flow Chamber

5.3.2 Sensor Installation

- ➔ **IMPORTANT:** Be careful not to turn the sensor or touch the membrane on the bottom of the sensor during installation. Oil on your fingers can block the small pores on the membrane surface.
1. Remove the sampling system front cover by unfastening the 4 plastic captive screws.
 2. Remove the sensor shorting plug or battery if supplied.
 3. Plug the methyl bromide sensor into the flow chamber inside the instrument housing.

NOTE: Do not twist the gas sensor inside the flow chamber. This may loosen the sensor cell box nut on the Methyl bromide renewable sensor cell and cause the electrolyte to leak.

5.4 Electrolyte Replacement (For Renewable Methyl Bromide sensor)

➔ **CAUTION:** Always wear protective gloves and safety glasses when replacing sensor electrolyte. Be sure to adhere to your facility's chemical handling guidelines and procedures.

1. Remove the sensor as outlined in section 5.3.
2. Place your finger over the pressure compensation port and turn the sensor upside down. Remove the box nut membrane, retainer ring, O-ring, and silicon sheet (depending on sensor model).

Methyl bromide sensor cell uses a White O-ring, p/n 86001 and Silicon Sheet is p/n 86002

NOTE: Replace O-ring and Silicon sheet only if damaged

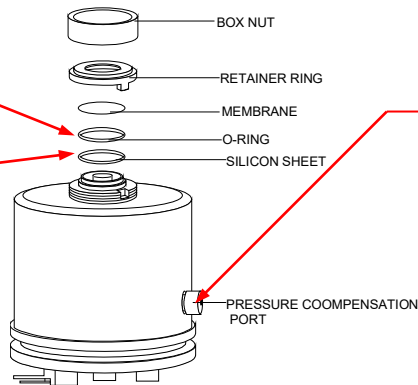

NOTE:

The Pressure Compensation Plug has a Teflon membrane fixed to the inside of the screw.

Never remove this membrane.

3. Place the sensor over the beaker as shown and pour the old electrolyte into the beaker. Some will remain in the sensor until the pressure compensation plug is removed. Remove the plug to release the electrolyte into the beaker.

NOTE: The Methyl bromide sensor cell uses an 8mm diffuser that is inside the Retaining Ring

Please DO NOT REMOVE THIS DIFFUSER

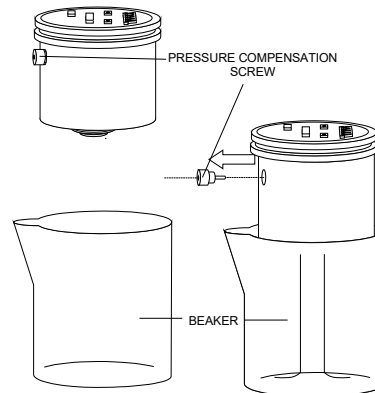

4. Hold the sensor in your hand with the sensing electrode up. Hold a piece of paper tissue over the pressure compensation port with your thumb. Pour 10 ccs of fresh electrolyte into the sensor and rinse. Discard into the beaker.

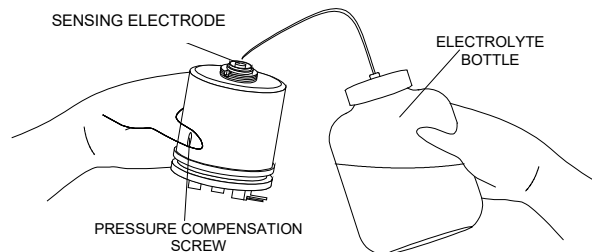

Electrolyte p/n 84004

5. Wipe the sensing electrode and the surrounding area with a dry paper tissue.

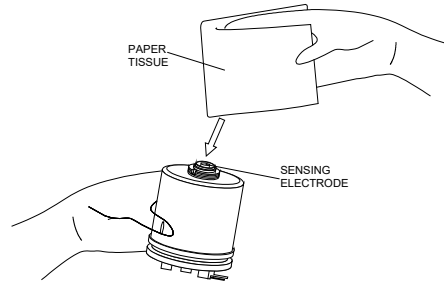

6. Place a new silicone sheet (if used) and O-ring on the sensor. Make sure that the area is dry of electrolyte.

NOTE: If reusing the old O-ring and Silicon sheet, please dry them thoroughly before reinstalling.

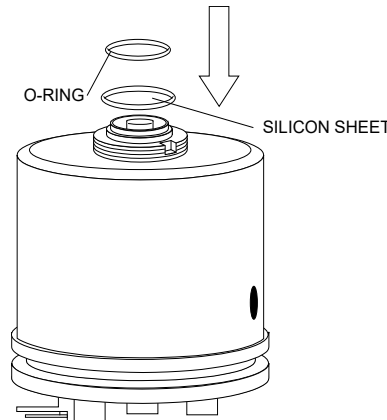

CH₃Br sensor cell uses a White O-ring, p/n 86001 and Silicon sheet, p/n 86002

Apply a drop of electrolyte on the sensing electrode.

Electrolyte P/N 84004

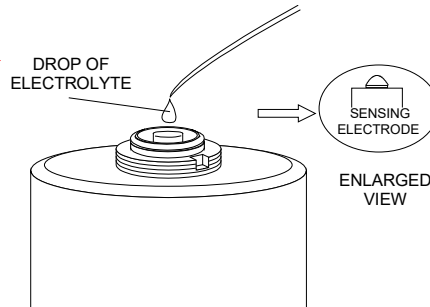

7. Place a new membrane on the sensor, with the bead of electrolyte between the electrode and the membrane.

White Membrane P/N M-4400M

Caution: A GREEN tinted paper separates each membrane.

DO NOT USE THIS PAPER

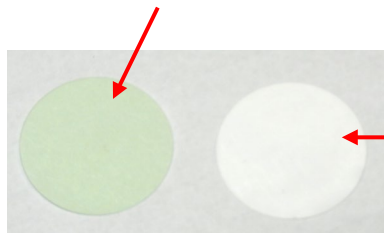
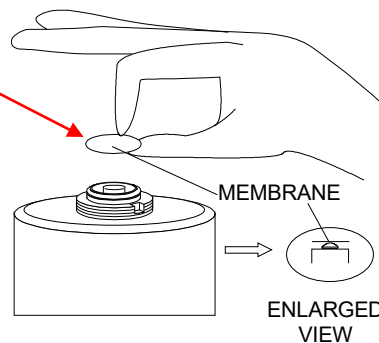

M-4400M Membrane Color is White

NOTE: Never touch the center of the membrane with bare fingers. Oil on your fingers can block the membrane pores.

- Place the retainer ring over the membrane and then place the box nut over the retainer ring. Turn clockwise until hand tight; continue tightening until the box nut can no longer be moved by hand.

➔ **CAUTION:** *If the box nut is too loose, the sensor cell response may be affected.*

NOTE: The Methyl bromide sensor cell uses an 8mm diffuser.

Please DO NOT REMOVE THIS DIFFUSER

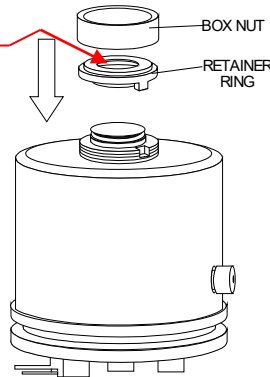

Hold the sensor in your hand with the electrode down. Pour fresh electrolyte in until it reaches the MAX. mark.

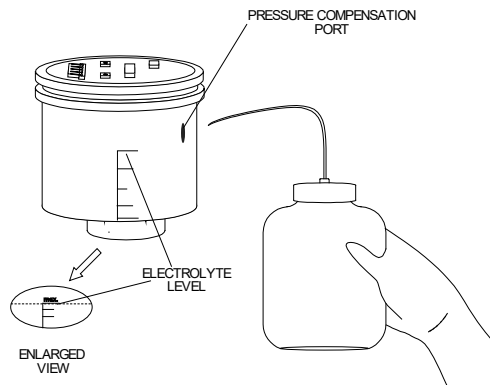

➔ **NOTE:** *MAX. level differs from sensor to sensor.*

- Wipe the pressure compensation port and its surrounding area with a dry paper tissue.

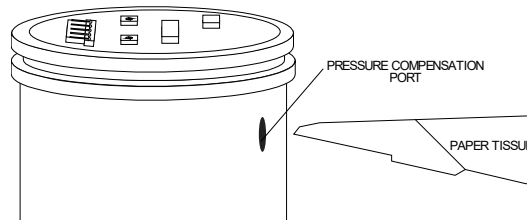

10. Insert the pressure compensation plug into the port.

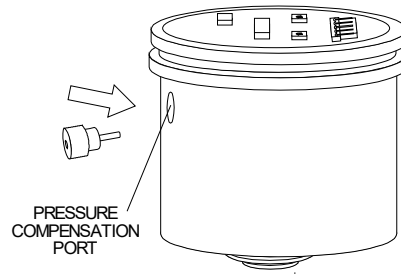

11. Reinstall the sensor as outlined in section 6.1.2.

NOTE: *When storing the sensor cell never store the sensor cell horizontal with the Pressure Compensation Plug positioned down or store the sensor cell upside down. This can cause the electrolyte to leak from the sensor cell pressure compensation plug.*

Example of proper membrane

Example of wrinkled membrane



5.5 System Calibration

The Air Check Methyl Bromide Monitor requires periodic calibration with the appropriate standard gas. Calibration should be performed whenever:

- Six months has passed without calibration
- The sensor cell electrolyte is replaced

5.4.1 Gas Generation and Calibrating Kits

For generating a calibrating gas, the following supplies are recommended. They are available by separate order.

| ITEM | PART NUMBER | DESCRIPTION | PACKAGING |
|------|-------------|--|---------------------|
| 1 | *90202256 | Span gas 5** ppm Bromomethane blended with air | 1 bottle 105 liters |
| 2 | 18102509** | Demand Flow Regulator | 1 each |
| 3 | 232-05A*** | Tedlar Sample Bag, 5 liter polypropylene fitting | 1 each |

* Purchase directly from: Absolute Accuracy Ph: 281-840-0781

** Purchase directly from: Industrial Scientific Ph: 800-338-3287

*** Purchase directly from SKC Ph: 724-941-9701

**** For higher range monitors please use order span gas concentrations that equal approximately $\frac{1}{2}$ the full scale value

5.4.2 Initial Preparation

NOTE: If the instrument is connected to a controller, set the controller to Standby mode to avoid accidental alarms.

NOTE: If the monitor was powered off, it is recommended to warm up the Methyl Bromide monitor for two hours before making any adjustments to the sensor.

5.4.3 Set Module Zero

NOTE: This procedure should be performed in a gas free atmosphere.

NOTE: Do not make any zero or span adjustments until the monitor has been operating for a minimum of 2 hours with a freshly recharged Methyl Bromide Sensor cell. Failure to do so will affect the calibration.

This is the menu at which to adjust the true zero reading on the Methyl bromide monitor. The selection permits setting system zero to a new or freshly recharged sensor cell. This procedure must be performed before challenging the monitor to a calibrated span gas. To perform this function, enter the Sensor Adjust Menu by pushing the joystick to the right. "Sensor Adjustment" will scroll.

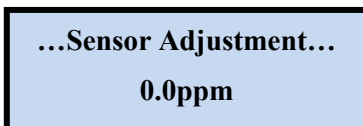

...Sensor Adjustment...
0.0ppm

There are 5 sub menus in the Sensor Adjustment Menu. Menus 1, 2, 3 & 5 are not used for the Methyl Bromide monitor. Menu 4 is the only menu used during calibration and sensor adjustment.

1. "Set sensor zero"
2. "Enable Zero Cal"
3. "Start Zero Cal"
4. "Set Module Zero"
5. "Enable Zero Tracker"

To adjust the monitors zero reading Select"

Push the joystick down to select the "**Set Module Zero**" menu. **Set Module Zero** will scroll.

Push the joystick to the right to enter the Zero adjustment mode.
To reset the zero Press **ENTER** to reset the zero and accept the new zero value.

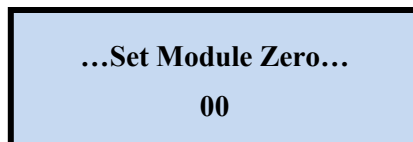

...Set Module Zero...
00

Push the joystick to the left **twice** to exit this submenu and return back to the Sensor Adjustment Menu.

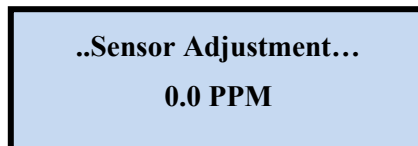

..Sensor Adjustment...
0.0 PPM

The Methyl bromide monitor zero has been adjusted and the monitor is now ready for calibration.

5.4.4 Gas Preparation

- ➔ **CAUTION:** *Be sure to observe all safety guidelines when generating and using calibration gases.*
- ➔ **NOTE:** Ensure that the span gas is within certification period
- ➔ **NOTE:** When using cylinder span gas, gas must be a mixture of the target gas blended with air.

1. Connect the Demand Flow regulator to the span gas cylinder
2. Connect ¼" flexible tubing to the output of the regulator

5.4.5 Span Calibration

To access the span function, while in the Sensor Adjustment Menu, push the joystick right until the "Set Sensor Span" menu appears. Push the joystick to the right to display the span menu.

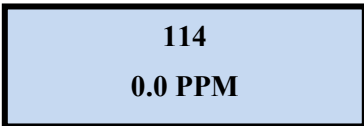

114
0.0 PPM

3. Connect the waste bag to the exhaust and open the valve on the waste bag and connect the system exhaust tubing to the gas waste tedlar bag. Inspect the flow rate to confirm flow is not blocked.
4. Connect the ¼" flexible tubing from the regulator to the inlet of the particulate filter. Expose the methyl bromide monitor to span gas for three (3) minutes. Adjust the display reading to the span gas by pushing the joystick up or down to set the concentration value on the PPM display.

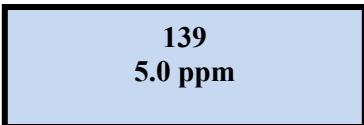

139
5.0 ppm

5. Press **ENTER** to accept the calibration value.
6. After calibration, disconnect the span gas from the monitor and permit the digital display to return to zero.

NOTE: The Air Check Methyl Bromide monitor has an internal pyrolyzer that converts the gas to bromine. Typical fall times can range from 1 to 4 minutes depending on the exposure concentration. The higher the concentration, the longer the fall time to zero.

7. Return the system to the monitoring mode by pushing the joystick to the left until the "CH₃Br" appears on the top line of the display. Reattach the front cover to the sampling system.

Note: The remaining span gas and collected waste gas should be properly exhausted.

Joystick for adjusting span

Push **UP** to increase the reading and **DOWN** to decrease the reading

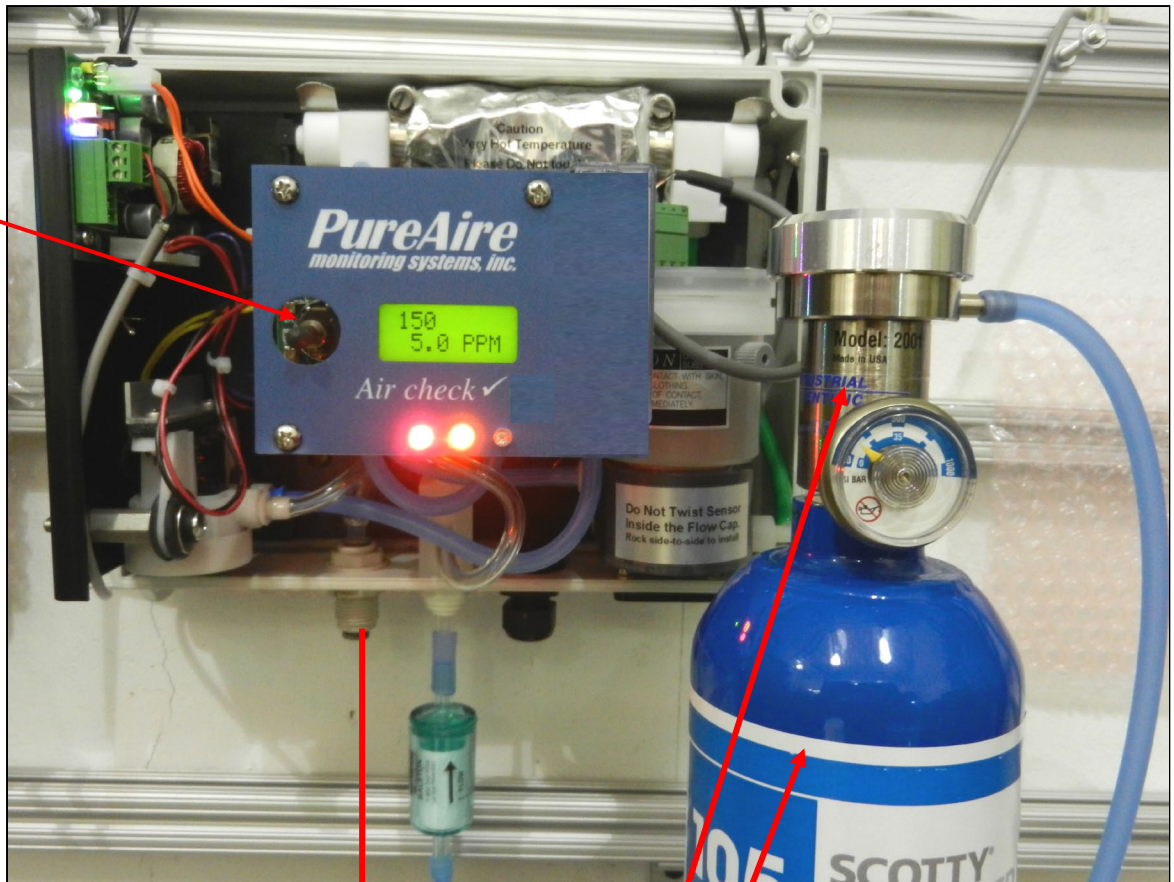

Methyl Bromide Waste Gas Bag 232-05A

Bromomethane span gas and On Demand Regulator

Span Gas 90202256

Regulator 18102509

6: Appendix

Location of 4ea. Front Cover Fastening screws

The Air Check monitor has 4 ea. Front Cover captive fastening screws on each corner of the front cover.

Use a Phillips head screwdriver to unfasten the screws to remove the front cover.

Please Do Not Over tighten



Location of the Sample Inlet and Exhaust connectors

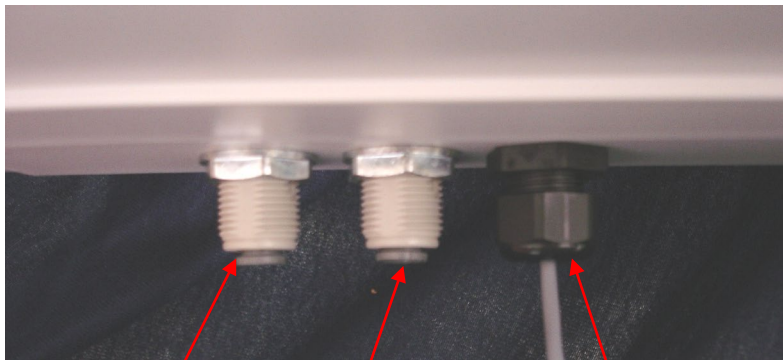

Sample Exhaust

Sample Inlet

Electrical Cable connector

Pyrolizer Assembly

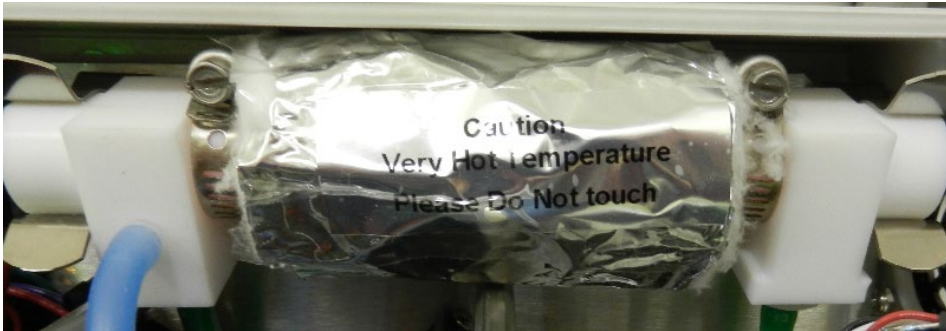

The pyrolizer insulation temperature can exceed 150F and can cause burns if touched.

Please power down the system when working inside the enclosure.

Air Check ✓ Sample Inlet Filter (p/n 23102)

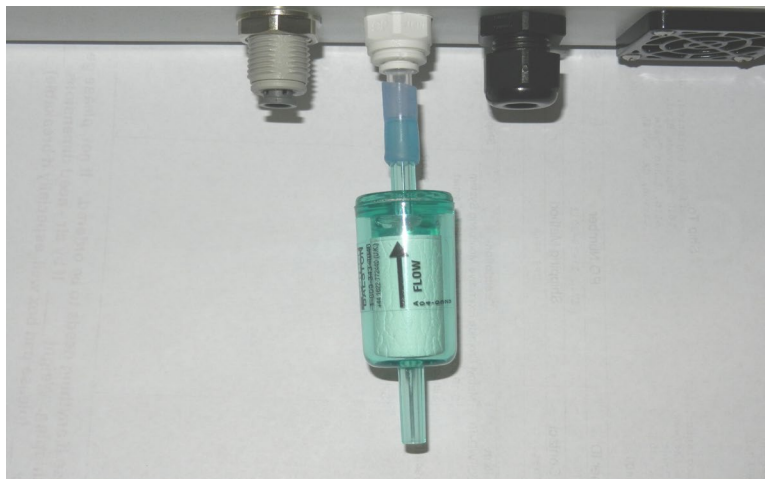

To protect the pump and pyrolizer from dust, the use of a particulate filter is supplied. On installation, attach the particulate filter to the inlet using the tygon sample tubing supplied. Ensure the correct flow by aligning the arrow towards the inlet connector.

NOTE: *If the filter gets saturated with water droplets, it will diminish the response of methyl bromide. When sampling from cold refrigerated environments please replace the filters frequently*